



I n t e r n a t i o n a l E n e r g y A g e n c y



IEA Task 21

Daylight in Buildings



**APPLICATION GUIDE
FOR DAYLIGHT
RESPONSIVE LIGHTING
CONTROL**

International Energy Agency
Task 21, Subtask B
February 2001

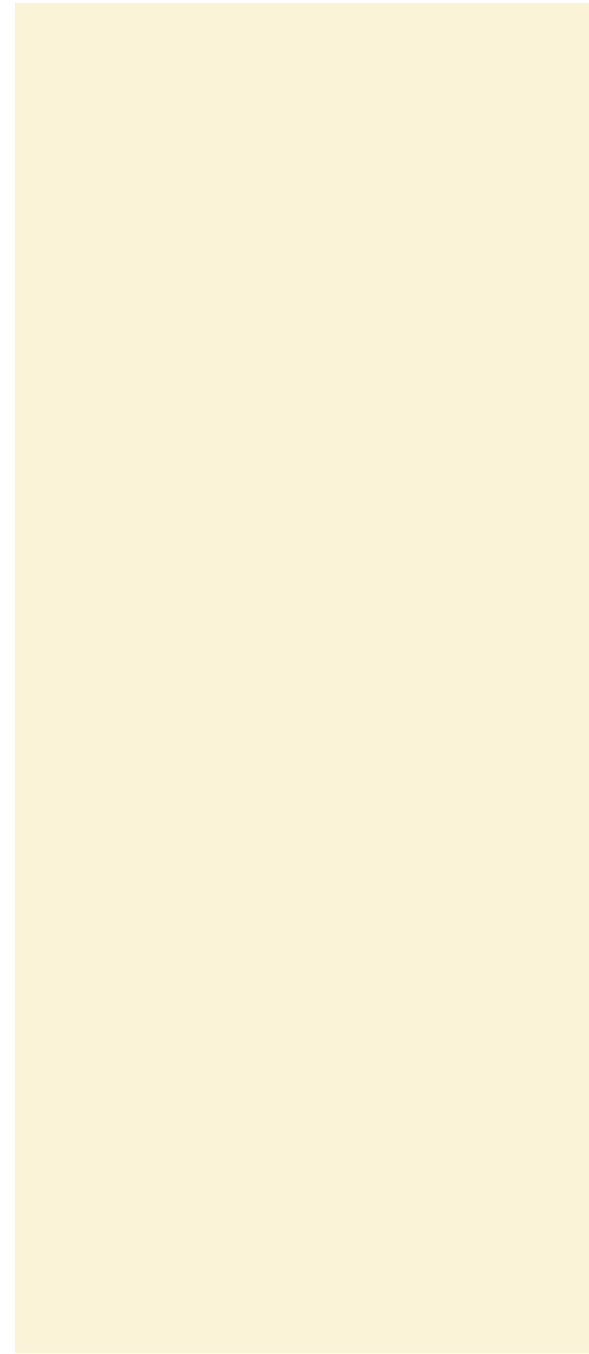

PREFACE

International Energy Agency

The International Energy Agency (IEA) was established in 1974 within the framework of the Organisation for Economic Co-operation and Development (OECD) to implement an International Energy Programme. A basic aim of the IEA is to foster co-operation among the twenty-one IEA Participating Countries to increase energy security through energy conservation, development of alternative energy sources and energy research development and demonstration (RD&D).



IEA Solar Heating and Cooling Programme

An important part of the Agency's program involves collaboration in the research, development and demonstration of new energy technologies to reduce excessive reliance on imported oil, increase long-term energy security and reduce greenhouse gas emissions. The IEA's R&D activities are headed by the Committee on Energy Research and Technology (CERT) and supported by a small Secretariat staff, headquartered in Paris. In addition, three Working Parties are charged with monitoring the various collaborative energy agreements,

identifying new areas for cooperation and advising the CERT on policy matters.

Collaborative programs in the various energy technology areas are conducted under Implementing Agreements, which are signed by contracting parties (government agencies or entities designated by them). There are currently 40 Implementing Agreements covering fossil fuel technologies, renewable energy technologies, efficient energy end-use technologies, nuclear fusion science and technology, and energy technology information centers.

The Solar Heating and Cooling Programme was one of the first IEA Implementing Agreements to be established. Since 1977, its 20 members have been collaborating to advance active solar, passive solar and photovoltaic technologies and their application in buildings.

Australia	Finland	Norway
Austria	France	Spain
Belgium	Italy	Sweden
Canada	Japan	Switzerland
Denmark	Mexico	United Kingdom
European Commission	Netherlands	United States
Germany	New Zealand	

A total of 26 Tasks have been initiated, 19 of which have been completed. Each Task is managed by an Operating Agent from one of the participating countries. Overall control of the program rests with an Executive Committee comprised of one representative from each

contracting party to the Implementing Agreement. In addition, a number of special ad hoc activities—working groups, conferences and workshops—have been organized.

The Tasks of the IEA Solar Heating and Cooling Programme, both completed and current, are as follows:

Completed Tasks:

- Task 1 *Investigation of the Performance of Solar Heating and Cooling Systems*
- Task 2 *Coordination of Solar Heating and Cooling R&D*
- Task 3 *Performance Testing of Solar Collectors*
- Task 4 *Development of an Insolation Handbook and Instrument Package*
- Task 5 *Use of Existing Meteorological Information for Solar Energy Application*
- Task 6 *Performance of Solar Systems Using Evacuated Collectors*
- Task 7 *Central Solar Heating Plants with Seasonal Storage*
- Task 8 *Passive and Hybrid Solar Low Energy Buildings*
- Task 9 *Solar Radiation and Pyranometry Studies*
- Task 10 *Solar Materials R&D*
- Task 11 *Passive and Hybrid Solar Commercial Buildings*
- Task 12 *Building Energy Analysis and Design Tools for Solar Applications*
- Task 13 *Advance Solar Low Energy Buildings*
- Task 14 *Advance Active Solar Energy Systems*
- Task 16 *Photovoltaics in Buildings*
- Task 17 *Measuring and Modeling Spectral Radiation*
- Task 18 *Advanced Glazing and Associated Materials for Solar and Building Applications*

- Task 19 *Solar Air Systems*
- Task 20 *Solar Energy in Building Renovation*

Completed Working Groups:

CSHPSS

ISOLDE

Materials in Solar Thermal Collectors

Current Tasks:

- Task 22 *Building Energy Analysis Tools*
- Task 23 *Optimization of Solar Energy Use in Large Buildings*
- Task 24 *Solar Procurement*
- Task 25 *Solar Assisted Air Conditioning of Buildings*
- Task 26 *Solar Combisystems*
- Task 27 *Performance of Solar Facade Components*
- Task 28 *Solar Sustainable Housing*
- Task 29 *Solar Crop Drying*
- Task 30 *Solar City (Task Definition Phase)*

Current Working Groups:

Evaluation of Task 13 Houses

PV/Thermal Systems (Definition Phase)

To receive a publications catalogue or learn more about the IEA Solar Heating and Cooling Programme visit our Internet site at <http://www.iea-shc.org> or contact the SHC Executive Secretary, Pamela Murphy, Morse Associates Inc., 1808 Corcoran Street, NW, Washington, DC 20009, USA, Tel: +1/202/483-2393, Fax: +1/202/265-2248, E-mail: pmurphy@MorseAssociatesInc.com.



Energy Conservation in Buildings and Community Systems (ECBCS)

The IEA sponsors research and development in a number of areas related to energy. In one of these areas, energy conservation in buildings, the IEA is sponsoring various exercises to predict more accurately the energy use of buildings, including comparison of existing computer programs, building monitoring, comparison of calculation methods, as well as air quality and studies of occupancy.

The Executive Committee

Overall control of the programme is maintained by an Executive Committee, which not only monitors existing projects but also identifies new areas where collaborative effort may be beneficial. To date the following have been initiated by the Executive Committee (completed projects are identified by *):

- | | | | |
|---|---|----|--|
| 1 | Load Energy Determination of Buildings* | 10 | Building HVAC Systems Simulation * |
| 2 | Ekistics and Advanced Community Energy Systems * | 11 | Energy Auditing * |
| 3 | Energy Conservation in Residential Buildings * | 12 | Windows and Fenestration * |
| 4 | Glasgow Commercial Building Monitoring* | 13 | Energy Management in Hospitals * |
| 5 | Air Infiltration and Ventilation Centre | 14 | Condensation * |
| 6 | Energy Systems and Design of Communities * | 15 | Energy Efficiency in Schools * |
| 7 | Local Government Energy Planning * | 16 | BEMS - 1: Energy Management Procedures * |
| 8 | Inhabitant Behaviour with Regard to Ventilation * | 17 | BEMS - 2: Evaluation and Emulation Techniques * |
| 9 | Minimum Ventilation Rates * | 18 | Demand Controlled Ventilating Systems * |
| | | 19 | Low Slope Roof Systems * |
| | | 20 | Air Flow Patterns within Buildings * |
| | | 21 | Thermal Modelling * |
| | | 22 | Energy Efficient Communities * |
| | | 23 | Multi-zone Air Flow Modelling (COMIS) * |
| | | 24 | Heat Air and Moisture Transfer in Envelopes * |
| | | 25 | Real Time HEVAC Simulation * |
| | | 26 | Energy Efficient Ventilation of Large Enclosures* |
| | | 27 | Evaluation and Demonstration of Domestic Ventilation Systems |
| | | 28 | Low Energy Cooling Systems* |
| | | 29 | Daylight in Buildings |
| | | 30 | Bringing Simulation to Application |
| | | 31 | Energy Related Environmental Impact of Buildings |
| | | 32 | Integral Building Envelope Performance Assessment |
| | | 33 | Advanced Local Energy Planning |
| | | 34 | Computer-aided Evaluation of HVAC System Performance |
| | | 35 | Design of Energy Efficient Hybrid Ventilation (HYBVENT) |

Contributors to this application guide:

Laurens Zonneveldt	TNO-TU Eindhoven
Heiko Belendorf	TU Berlin
Bjørn Brekke	SEFAS
Catherine Laurentin	ENTPE
Shauna Mallory-Hill	TNO-TU Eindhoven
Ferdinando Raponi	ENEA
Frans Taeymans	Etap Lighting
Ariadne Tenner	Philips Lighting
Martine Velds	TU Delft

Participating institutions, IEA Task 21, Subtask B**TNO-TUE**

Centre for Building Research
P O Box 513
5600 MB Eindhoven, The Netherlands

Philips Lighting BV

P O Box 80020
5600 JM Eindhoven, The Netherlands

Etap Lighting N.V.

Antwerpsesteenweg 130
B-2390 Malle, Belgium

Technische Universität Berlin

Institut für Elektronik und Lichttechnik
FG Lichttechnik, Sekr. E6
Einsteinufer 19
10587 Berlin, Germany

Delft University of Technology

Faculty of Architecture
P O Box 5043
2600 GA Delft, The Netherlands

ENEA, SIRE

Systems and Components for Energy Savings
Casaccia
00060 S.M. di Galeria, Roma, Italy

ENTPE/DGCB

Rue Maurice Audin
69518 Vaulx-en-Velin, Cedex, France

SEFAS

7491 Trondheim, Norway

Helsinki University of Technology

Otakaari 5 A
02150 Espoo, Finland

TABLE OF CONTENTS

TABLE OF CONTENTS

EXECUTIVE SUMMARY	5
GENERAL INTRODUCTION	7
CONTROL SYSTEMS	11
2.1 Introduction	11
2.2 Properties of daylight.	11
2.2.1 Thermal aspects of daylighting	11
2.2.2 Psycho-physiological aspects of daylighting	11
2.3 Daylight control systems	12
2.3.1 Manual control systems for daylight control	12
2.3.2 Automatic systems for daylight control	12
2.4 Objectives to use daylight responsive artificial lighting control systems.	13
2.4.1 Energy savings and durability.	14
2.4.2 Economics	14
2.4.3 Comfort	15
2.5 Control strategies	15
2.5.1 Control principles.	15
2.5.2 Level of control	16
2.6 Daylight responsive control systems for artificial lighting	17
2.6.1 Working principle	17
DECISION SUPPORT IN THE SELECTION OF CONTROL SYSTEMS	19

3.1 Introduction	19
3.2 Is daylight responsive control feasible?	19
3.2.1 Lighting demands	20
3.2.2 Daylight availability	20
3.2.3 Electric Lighting System	22
3.3 Which control system?	22
3.3.1 Control requirements	22
3.3.2 Economics	23
3.3.3 Ergonomics	25
3.3.4 Decision table	26
PREDICTION OF ENERGY SAVINGS AND COSTS	29
4.1 Introduction	29
4.2 Frequency method to predict direct savings from daylight responsive controls	32
4.2.1 Reference situation for energy use	34
4.2.2 Electric lighting	34
4.3 Calculating the energy saving potential	36
4.3.1 TU Berlin method for describing and predicting the energy saving potential ...	36
4.3.1.1 Room potential	36
4.3.2 Availability of daylight	37
4.3.2.1 Relative usable light exposure	37
4.3.2.2 System potential	38
4.3.4 The average sky condition	38
4.4 A simplified method to characterise the efficiency of daylight systems	38
4.4.1 Introduction	38
4.4.2 Calculation method	40
4.4.3 Explanation of the calculation	40
4.4.4 Examples	41
4.4.5 Results and conclusions	41
4.5 Laboratory Test Methods - Daylighting Box	44

4.5.1	Experimental set-up	44
4.5.2	What is recorded?	45
4.5.3	Evaluations	45
4.5.4	Application	45
4.6	Scale model testing of daylight responsive lighting control systems	45
USER REACTIONS TO DAYLIGHT RESPONSIVE CONTROLLED LIGHTING		47
5.1	Introduction	47
5.2	User awareness	47
5.3	Acceptance	48
5.4	Things to remember	48
INSTALLATION PROCEDURES.....		51
6.1	Introduction	51
6.2	Installing sensors for closed loop systems	51
6.3	Installing sensors for open loop systems	51
6.4	Installing Luminaires with built-in sensors	52
6.5	Installing room-based systems	53
6.6	Installing building-based systems	54
6.7	System awareness	55
6.8	Selecting a consultant	55
MAINTENANCE AND FLEXIBILITY		57
7.1	Introduction	57
7.2	The first stage: evaluation of initial performance	58
7.3	Changes in the required lighting conditions	58
7.4	Ageing of components.....	59

7.5 Malfunctioning of components 60
7.6 Maintenance program 60

DESIGN EVALUATION 63

8.1 Introduction 63
8.2 Evaluation of the design 63
 8.2.1. Technical evaluation 63
 8.2.2 Maintained illuminance level 63
 8.2.3 Energy savings 63
8.3 User acceptance evaluation 64

OUTLOOK 65

FURTHER READING 67

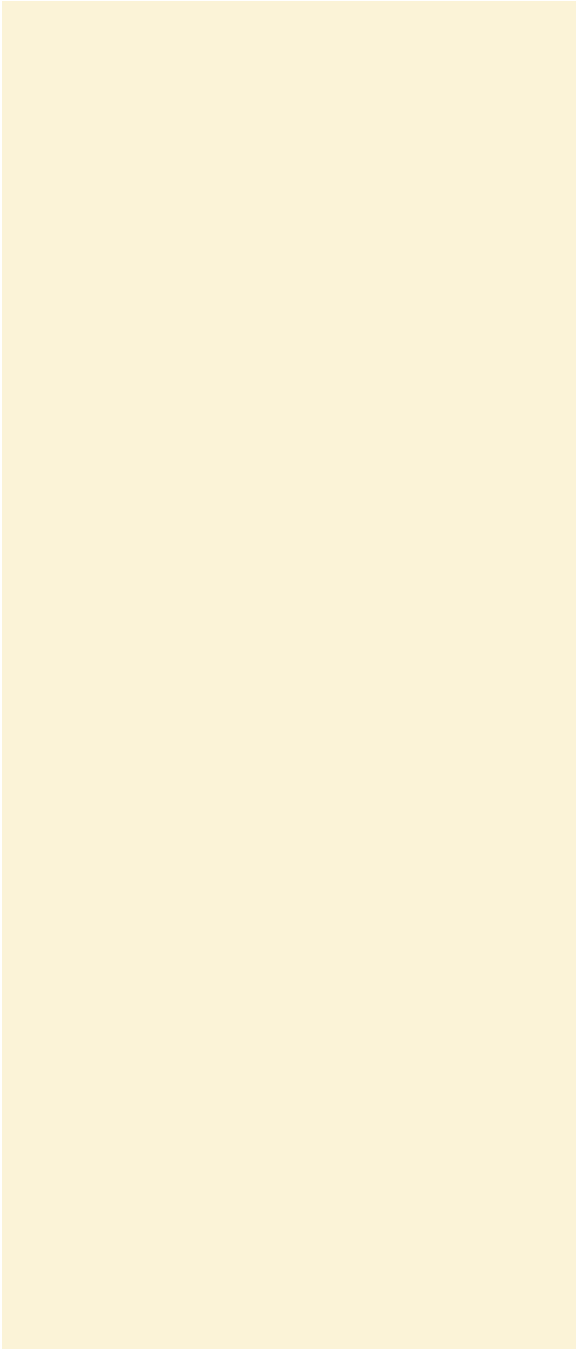

EXECUTIVE SUMMARY

**EXECUTIVE SUMMARY**

Daylight responsive control of lighting applies both to the control of the artificial light and dynamic control of the distribution and amount of daylight. Objectives for using daylight responsive controls are energy savings, visual comfort and reduction of cost. It is a prerequisite that windows are used as a light source, not just for a view. Also proper integration of daylight and artificial lighting is important. The eventual savings depend very much on the behavior of the user.

Finding the right solution

The best approach to come at a good solution is to first optimize daylight in terms of levels and distribution in the space. This does not mean that daylight will supply sufficient light for illuminating the room and the visual task(s) all the time and thus eliminating the need for artificial light. It means to look for a solution that gives a significant contribution of daylight, with little annoyance for the user. Typically a daylight factor of 1-3% up to two times the room height from the façade is a suitable target.

Daylight systems will in general not improve the amount of daylight but are often needed to improve the distribution of the light and avoid glare.

Control of daylight is mostly manual. Automatic control is often based on illuminance/irradiance of the façade. This criterion is used to avoid direct sunlight entering the space. Only very few still experimental systems exist that really intent to control daylight conditions in the interior and are based on criteria related to visual comfort other than avoiding direct sunlight.

Electric lighting and daylight have to cooperate in order to achieve the goals of energy efficiency and good visual comfort. Therefore the layout of the electric lighting has to be designed in such a way that suitable zones are created and daylight is supplemented in each zone. The daylight responsive control system of the electric lighting has to take care of this. There is quite a variety of daylight responsive control systems for artificial lighting on the market. The main objective of this guide is to support the user in selection, installation and maintenance of such a system.

What are the benefits?

Daylight responsive controls systems may give you significant savings on electricity for lighting at an unaffected visual comfort level. In a number

of practical demonstrations energy and comfort aspects are evaluated. In the conclusions of this book it is shown that the actual savings from different types of systems do not differ much: almost all systems save a significant amount of energy. More essential differences between systems are in the user interface and adaptability to user demands.

Once the step is taken to install daylight responsive lighting at little more cost other advanced controls may be available. Not only controls for lighting but, in the case of building based systems, control over shading may also be made available to individual users. Also when the users are absent (e.g. at night) the controls may be used for climatic control of the building.

What will be the future?

As can be seen in this guide the developments in electric lighting controls have led to a vast number of satisfactory performing systems. The actual savings from these systems strongly depend on the use of shading. Future developments therefore will be more in the direction of improved daylight systems that are adjustable, or automatically adjusting to daylight availability. This will increase the benefits of daylight responsive

lighting even further and will also lead to optimize working conditions with respect to visual comfort and thermal environment. Current developments aim at more distributed logic replacing the centrally controlled systems. The central computer is then mostly used for issuing building wide commands, inputs and monitoring performance.

CHAPTER 1



GENERAL INTRODUCTION

Daylight is generally preferred above electric lighting. It is free and has perfect colour rendering and a positive effect on human well-being. Daylight is associated with a view on the weather and the exterior. Moreover daylight is a dynamic in many ways. A lighting designer, who intends to illuminate demanding visual tasks, such as found in office work, with daylight, should take special care.

Daylight consists of three components. The first daylight component is the direct beam from the sun. The second is the daylight scattered in the atmosphere (including clouds) resulting in the diffuse sky component. Thirdly some daylight comes from reflections on the ground and objects in the exterior environment. Daylight is by its nature a source that varies constantly in intensity, colour and luminance distribution. These variations of daylight are characterised in time by periodical and random variations on some typical time scales (see insert).

Using daylight as a source for illuminating tasks in the working environment demands special means to handle this dynamically changing source. Generally the continuous variations in daylight availability require adaptable shading devices and electric lighting systems to keep luminance ratios and variations in the interior within the acceptable bounds.

Often daylighting systems are used. A daylighting system is an adaptation of a plane

clear daylight opening in order to distribute daylight in a space and/or reduce the luminance of that daylight opening. Even if the most ideal daylighting system is installed, it is always necessary to provide electric lighting. At night, or on dark winter days, electric lighting must be able to provide all necessary lighting. During the day whenever daylighting provides an insufficient or incorrect distribution for a particular task, electric lighting will be used as additional source of light. Daylight responsive lighting controls are an invaluable tool to supply the right amount of electric light there and when it is needed.

The use of automatic daylighting or electric lighting controls will have influence on the energy balance of a building. Daylight responsive controls will provide a means to optimally benefit of the natural light source, and thus energy will be saved. On the other hand, the control electronics and sensors also use energy. This energy use for the controls can be significant (up to 10% of all energy for lighting) in cases where complex building management systems with additional controls such as occupancy sensors are used in combination with highly efficient lighting. Also the use of daylight linked lighting control will have an influence on the energy used for heating and cooling of the building. The balance between these factors should be carefully estimated.

Objectives of this application guide

The purpose of this book is to guide designers in selecting, installing, and using daylight responsive

devices for daylight as well as for electric lighting. As these systems are relatively new and many aspects of their implementation and use are unknown, this guide also addresses the commissioning and maintenance of these systems. Everyone involved in the design of building installations can benefit from the information contained in this guide. Practical aspects and experiences are shown in cases describing what has been learned from the use of daylight responsive controls in real buildings.

This application guide for daylight responsive lighting controls is the key product of the work in Subtask B of International Energy Agency (IEA) Task 21.

Contents of the Application Guide

The flowchart shown in figure 1 illustrates the design process for integrated daylight and electric lighting. It focuses on lighting that is controlled on the basis of daylight availability. It also gives the relationship with the IEA task 21 Subtask A Source Book on daylighting systems.

This scheme illustrates that in order to save energy for electric lighting a proper daylighting design must be made. Guidance for this daylighting design can be found in the subtask A Source Book.

This design task starts with laying down the 'Boundary Conditions' together with the client. In the next stage the 'Daylighting Design', consisting of windows and shading, is made meeting these boundary conditions.

The established daylighting design is analysed carefully in 'Analysis Daylighting Design', which is

part of the Subtask B and is described in the second chapter of this guide. When the results of the analysis match the criteria that were set for both the quantity and quality of the daylight in the interior of the building the process is continued with the 'Artificial Lighting Design', which will not be discussed in this guide. If the results do not meet the criteria the designer can either try to improve the 'Daylighting Design' or decide to make the design for the artificial lighting without daylight responsive lighting control. In the next stage controls for daylighting and the electric lighting are added in 'Control System Design'. The aspects involved in this stage are discussed in the chapters 2, 3, and 4 of this guide. Installation related topics are dealt with in chapter 6.

Maintenance schemes form an important product of the design: good maintenance will help to optimise savings and is discussed in chapter 7.

It is important to have feedback on the performance of the total lighting installation. Therefore a chapter on evaluation of the design is included (chapter 8).

Time scales in daylight

The first period is the twenty-four hour variation between day and night that is caused by the rotation of the earth.

The other typical frequencies in the variations of daylight are determined by the weather. Depending on the climate some types of weather can last from a few days, to a week, or sometimes a whole season. The type of clouds involved in the weather type mainly causes the variations in daylight. Clouds have an inhomogeneous density and often several layers of clouds are moving with different speeds. So also if there is an overcast sky, there is a continuous variation in the daylight contribution, although human beings often do not notice it. These variations in cloud density cause variations in illuminance distribution of approximately 25-40% on a time scale of 5-10 minutes; slow enough for the eye to adapt to it.

Overcast sky

An even more complex situation arises when the cloud layers are not continuous i.e. when the sky is partly clouded. Then there is not only the variation in density, but also the effect of the sun that is sometimes visible and sometimes not. An additional complication is that the sunlight reflects on the separate clouds. The brightness of those clouds that reflect the sunlight can cause problems of visual discomfort, and also increase suddenly the intensity of the daylighting. During partly cloudy days variations on a small time scale (5 seconds to 5 minutes) and with large dynamics (200-300%) will be too disturbing for most people in working environments.

Clear sky

Most constant is the situation with a clear sky. In the course of the day the amount of daylight changes gradually with the sun's position in the sky on a time scale of hours.

Table 1:

Relation between the activities in IEA task 21, Subtask A and Subtask B, and their contributions to improvement of lighting design.



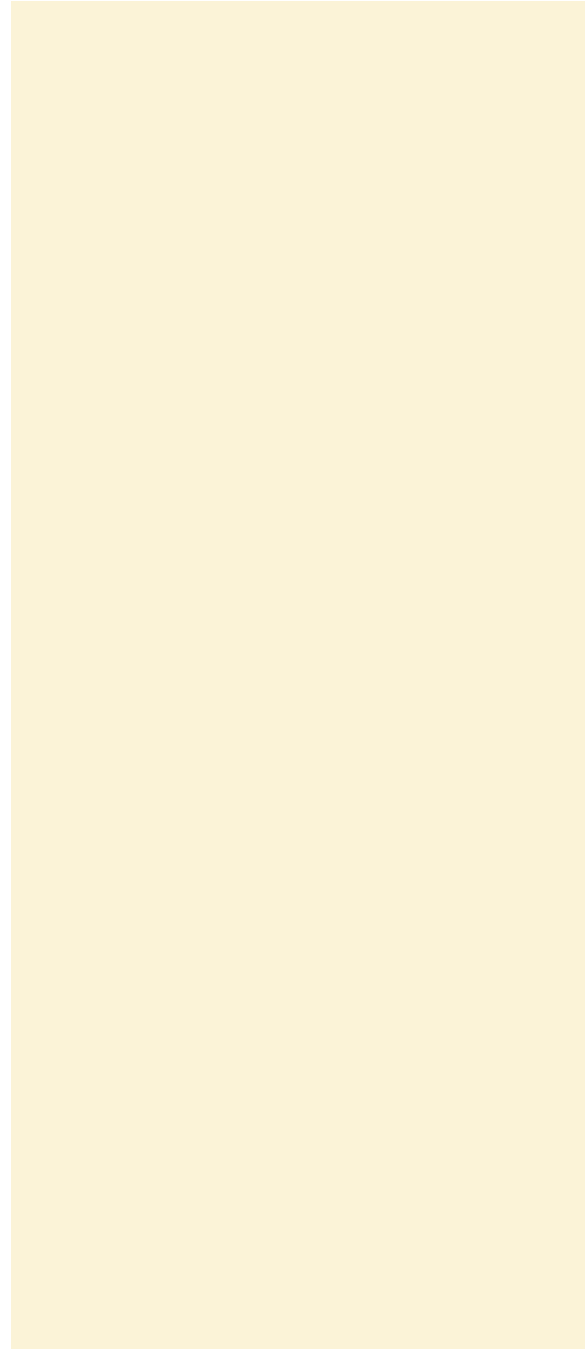

CHAPTER 2



CONTROL SYSTEMS

2.1 Introduction

This chapter introduces the reader to daylight responsive control of lighting. In most cases only the electric lighting is controlled as this has the most obvious impact. Although daylight is an unpredictable and constantly changing source, the control of daylight through moving shutters or blinds or through other forms of adaptive daylight openings can be desirable.

This chapter discusses the control systems themselves, introduces a number of practical design and installation issues and gives the principles behind the electric lighting control systems.

2.2 Properties of daylight.

Daylight can be characterized as a highly efficient light source with full-spectrum light, giving a perfect colour rendering, large variations in colour appearance and intensity, and a variable direction of the major light incidence. The availability and the characteristics of the daylight are depending on latitude, climate, weather, time of the year and time of the day. In some climates the daylight can be predictable in other climates very unpredictable.

Daylight is an interesting light source, but it

should be controlled (through solar shading, dosing and/or redirecting of the natural light) in order to make it useful for lighting the working environment. Even in the best daylit buildings, a need remains for complementary- or substituting artificial lighting.

With a daylight responsive control system daylight can be used to reduce the energy consumption for electric lighting.

2.2.1 Thermal aspects of daylighting

Windows and daylighting systems influence the distribution of daylight and the thermal load of a building. A daylighting system can help to reduce the heat gains in the building due to the favourable lumen per watt ratio of daylight and save on energy for cooling. This implies a careful dosage and distribution of the daylight along with a properly working artificial lighting control. Daylight responsive control of lighting is often combined with thermal control. When no occupants are present thermal control will reduce heat gains in summer by closing the shades in daytime to keep out the heat and opening the shades during the night to cool by radiation. In winter this may be reversed.

2.2.2 Psycho-physiological aspects of daylighting

It is widely recognised that the composition, quantity and variation of the natural light is experienced by human beings as pleasant and stimulating. It can even prevent or cure sickness; e.g. the light treatment of SAD (Seasonal Affective Disorder).

A very important psycho-emotional factor is the visual contact with the exterior.

Today some manufacturers of artificial lighting systems produce artificial dynamic light surroundings and special desk-luminaires for treatment, curative as well as preventive, of various symptoms concerning the circadian rhythm, such as sleeping problems, fatigue, lowered mood etc. Although the Task 21's major objective is energy saving through promoting daylight use, one has to consider that perhaps the indirect savings, through good daylight application, leading to a more pleasant surrounding of a higher quality, are even more important than the direct energy savings. Therefore it is extremely important that the daylight on the workplaces is applied in a comfortable and ergonomic way, assuring that the users accept the applied daylighting and the various daylighting related control systems, also in combination with the tasks they have to perform (daylight can cause considerable glare).

2.3 Daylight control systems

There are several ways to control the amount and distribution of daylight entering a space (see Subtask A). Firstly window size and position in the façade determine most of the potential to utilise daylight. Secondly the transmission characteristics of the glazing determine the maximal flux of daylight. Based on window size and transmittance a daylighting system is selected and dimensioned. A daylighting system is an adaptation of the window aimed at improving the amount and distribution of

daylight in the space. The selection depends on factors such as external obstructions, climate and the desired interior lighting conditions.

Daylighting systems can consist of fixed and/or movable elements (see figure 1). Fixed daylight systems are for instance overhangs, fixed light shelves or other light redirecting elements.

In case of movable elements these may be controlled manually or automatically. The automatic control can be based on daylight availability.

2.3.1 Manual control systems for daylight control

These are the systems enabling the user manual control over the quantity and quality (i.e. avoiding glare) of daylight in the rooms. They can range from very simple widely-used diffusing curtains or venetian blinds to very sophisticated light re-directing systems aiming to optimise the quantity and quality of the natural light incidence.

2.3.2 Automatic systems for daylight control

Automatic systems can perform a wide range of actions. They will tilt or turn horizontal/vertical lamellae, lower or rise curtains, rotate sun-tracking systems etc.

Many of these systems are not responding to overall daylight availability. Their actions may also depend on the direct sunlight or solar position only. Examples are shading controlled on the basis of direct sunlight, which use a roof-based sensor measuring total

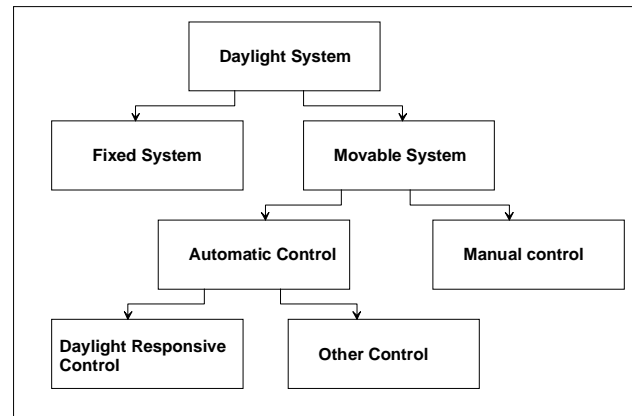

Figure 1 Overview of types of shading systems

radiation on a tilted surface, controls for tilting blinds based on astronomical data for solar position and controls of heliostats based on solar position.

Daylight responsive daylight control systems consist of a sensor, measuring incident flux, and control system acting according to the sensor's signal.

For all control systems yields that the best functioning systems are preferably unnoticeable to the users

2.4 Objectives to use daylight responsive artificial lighting control systems.

There are several reasons to apply daylight responsive artificial lighting control systems,

such as:

Energy saving.

A number of lamp types can be dimmed using electronics. Dimming will lead to a reduction of energy consumption; however, the electronics added to enable dimming (or other forms of electronic control) require energy to operate. Most of the popular fluorescent lamps (T8, T5 and compact lamp types) are easily dimmable with a significant reduction in energy use. But the reduction of light output and energy consumption are not equal: a fully dimmed fluorescent tube may have a light output of 2% of the maximal light flux and will still require 20% of the energy consumption at 100% light output. This is because of the energy consumption of the ballast and the lower efficacy of the dimmed lamp. Reducing the energy consumption for the lighting also reduces the cooling costs because less heat is produced by the lighting.

Economics - reducing the running costs of the building.

An initial investment in energy efficient dimmable lighting may seem expensive at first but can have significant benefits over the years. One has to look at lighting costs in terms of cost of ownership, not just as an investment separated from using and maintaining the installation.

Occupant's comfort.

People are the main capital of most organisations. Taking care of them is a key factor in success. The benefits of good lighting are often underestimated. Recent research shows more and more how important lighting is in the total working environment. A lighting

control system can improve the comfort by balancing the brightness ratios in the room. Furthermore lighting control systems can offer additional features such as automatic and remote control.

In the following paragraphs these issues will be discussed.

2.4.1 Energy savings and durability.

Electric energy is generally created through conversion of primary energy sources (such as coal, natural gas or nuclear energy). It is inevitable that energy is lost in this conversion process. Also transport losses of electric power along wires may be considerable. Saving electric energy is therefore an important means to reduce CO₂ and other wastes.

Daylight is freely available and renewable. The main drawbacks are the thermal load that may come from windows and (in most climates) the unpredictability of the daylight. The total possible energy saving in a building by using daylight is a combination of “direct” energy savings on the artificial lighting by dimming when there is enough daylight available and the dimming of new lighting installations which always are “over-dimensioned”. New equipment is typically over-dimensioned by 10-25% anticipating the normal depreciation; so even without the utilisation of daylight linked dimming a considerable energy saving can be achieved. Also the cooling load will be reduced, resulting in energy saving on cooling (if building is equipped with a cooling system)

2.4.2 Economics

Initial cost, cost of ownership and energy costs etc., are other issues. With the current (1999) low energy prices the payback time may seem long, but there are other arguments to invest in expensive installations, like flexibility, comfort and prestige.

The major economical arguments are presented here. Peak electricity consumption reduction is an important “direct” economical argument; a typical energy consumption pattern shows a coincidence of low artificial lighting demands with high cooling demands; daylight responsive control systems can therefore result in a considerable lower peak demand. Cheap and simple systems with only daylight responsive control of the lighting exist and offer a reasonable payback period.

The acceptance of the system by the user is perhaps the most important indirect economical aspect. If a control system is not-accepted by the user it will probably be sabotaged and the productivity of the workers might be reduced. A slightly reduced productivity of dissatisfied workers can spoil all expected savings. Current (1999) annual electricity consumption for artificial lighting in modern offices costs per person barely as much as one-hour employee’s wage.

Subsidising policies and/or tax advantages for energy saving measures are offered by some governments. Both for retrofit and new buildings it is always worth checking the local policies; in most cases, electricity suppliers are the intermediaries.

With the high-ranking bus-systems the lighting equipment can be easily adapted for other tasks or

users. They also give the possibility to reconfigure switched- or controlled groups in case of layout changes. For big buildings with a high re-conversion rate this can be of economical interest.

2.4.3 Comfort

User comfort can be enhanced by offering appropriate lighting conditions; remote control, scenario possibilities and dynamic lighting for the more complex systems.

It is generally accepted that there is a correlation between user comfort and productivity, which makes comfort and acceptance also important economical items. Lighting design is always a compromise and not everybody will like it. Adding remote control possibilities gives the users a feeling of control over their environment.

It is also possible to install higher lighting levels, up to 700-800 lux, while the installation is normally running at levels around 500 lux, but offers the possibility to have the higher levels when required.

2.5 Control strategies

The concept "lighting control" covers a number of different methods that are used in lighting systems to change the lighting in a space. A control system may be manual (like an ordinary

switch or a remote controller) or automatic (based on monitoring by a sensor system or a clock), and it may operate on different parameters of the lighting installation, like:

- The light level (illuminance / luminance)(amount of light, dimming)
- The light distribution (directional control)
- The spectral distribution (the colour) (like in theatre lighting)

The control systems that control the light level are the most common systems to use.

The automatic lighting control may be based on one or more of the following control criteria

- Daylight access (The electric light is controlled by the amount of daylight available)
- Absence of persons (The light is automatically turned off in unoccupied rooms)
- Time (like automatic on/off switching of the light at fixed hours)

Control systems based on daylight access are called daylight responsive control systems.

2.5.1 Control principles.

Control of the light level can be achieved by continuous dimming, step dimming or on/off switching.

The dimming systems may be divided into 2 categories according to the position of the sensor:

- A so-called '*open loop*' control system; a predetermined control system, measuring the appropriate daylighting level (i.e. illuminance on the roof or façade) or a daylight-related luminosity (i.e. luminance of solar shading devices or window-view) and controlling the artificial lighting using some predetermined algorithms.
- a so-called '*closed-loop*' control system; a feed-back control system, measuring the workplace's entire luminosity level (sum of the daylight plus artificial light); mostly at several places in the room.

According to the dimming behaviour two types of systems can be distinguished:

- *Proportional systems*, where the dimming is performed proportionally to the measured daylight level or total light level in the room.
- *Constant holder systems*, where the dimming is performed in such a way that the sum of daylight levels and artificial light level is constant. In practice, since the dynamic range of the daylight level often is much higher than the dynamic range of the artificial light level, the "constant holding" is only possible within a limited range of light levels. Constant holder systems are always "closed-loop" systems.

2.5.2 Level of control

An electric lighting installation (as well as the daylight systems) may be controlled on several levels:

- individual control; the electric lighting is then controlled by a so-called *luminaire-based control system* (Each luminaire has its own control system, like individual workplace luminaires or luminaires for general office lighting equipped with an individual sensor and dimming- or switching system).
- room control; (All luminaires on the same circuit are controlled by one control unit. All luminaires can be dimmed in the same way or with master-slave principle the lamps in the interior of the room can have an offset, leading to less dimming. If the control is applied to all luminaires in one room; this is called a *room-based control system*)
- building control (Luminaires with more or less identical positions are controlled simultaneously, like a window row of luminaires). Several groups from an entire building linked together in a network or to a central control system is sometimes called *building-based control system*.

Control systems vary widely in complexity and capabilities. The simplest systems consist of a standalone control system which just dims the lamps according to the luminaire's surroundings luminance. On the other end of the range complex bus-based building management systems exist, which control not only the lighting but also equipment like the solar shading and HVAC and offer the possibility of remote control, pre-set scenarios, switching/dimming according to occupancy, etc.

Total sun's irradiation (visible radiation + IR + UV) can be more the 1000 W/m².

A part of the sun's radiation consists of visible radiation (light). It is impossible to bring in high light quantities without significant increase of the heatload; also by absorption light is transformed in heat.

Good dosed natural light can help reducing the internal heatload because of the high lumen per watt ratio..

The worker's capability to influence his surrounding (self-decision latitude) is very important.

Colour temperature (T_c) of daylight variations > 3000K; between warm-white and higher than 7000 K cool white.

Illuminance levels vary from 0 to 100.000 lux (100.000 lm/m²). During variable weather conditions, illuminance can change in a few seconds from 20.000 to 100.000 lux.

Total power irradiation (incl. UV and IR) up to more than 1000 W/m².

Light efficiency of daylight is up to more than 120 lm/W; in comparison efficiency of best fluorescent lamps (incl. control gear) is +/- 90 lm/

2.6 Daylight responsive control systems for artificial lighting

Daylight responsive control systems for artificial lighting are automatically acting systems that will control the artificial lighting as a function of the natural light available in the space. A daylight responsive control system is expected to maintain the designed lighting level or a user selected level in all circumstances, all the time on the whole designated work surface, without annoying the user, preferably unnoticeable to him. Depending on the amount of daylight a significant amount of electric energy for lighting can be saved.

2.6.1 Working principle

These systems consist of two main units:

- The sensor unit. This is a photosensitive element (photodiode, phototransistor, Light Dependent Resistor) with an optical unit, which determines the "visual field" of the sensor. It may also have a spectral filtering device in order to match the spectral sensitivity of the sensor to the sensitivity of the human eye. The sensor unit may be designed to be mounted on the luminaire, at the ceiling, on the inside wall or on the outside wall or even on the roof. In many cases the sensor unit must be tuned to the required illuminance level or range of levels (sometimes this has been done in the factory).
- The operative unit. This contains an electronic part which can be adjusted to the

individual room. The unit also contains the dimming or switching element, which is positioned either centrally (for circuit or group control) or within the luminaire (for individual control).

The dimming systems are dominating the lighting control market. This is mainly due to a higher saving potential than the others.

The control system interprets the sensor's signal(s) and switches or dims the artificial lighting according to the daylight conditions. The algorithms used in this process can be various; ranging from maintaining a simple pre-set switching level to computer-controlled, fuzzy-logic inspired algorithms. As already mentioned before, the bus-based systems or building management systems generally can do more than only daylight responsive control of the electric lighting.

Generally closed loop systems need simpler control algorithms than open loop systems. Many room-based and building-based control systems are open loop systems; in order to avoid user's dissatisfaction they need to have a delayed action.

Luminaire-based control systems are always closed-loop systems and may be quick responding.

The actual energy saving potential through daylight responsive control systems is rather restricted because typical modern office lighting equipment's consumption, even without controls, is less than 10-15 W/m².

In relative terms, a good functioning daylight responsive control system can save 20 to 50% on lighting energy (see, for example, part B of the Application Guide).

Actual available combinations with presence detectors, can strongly enhance these savings.

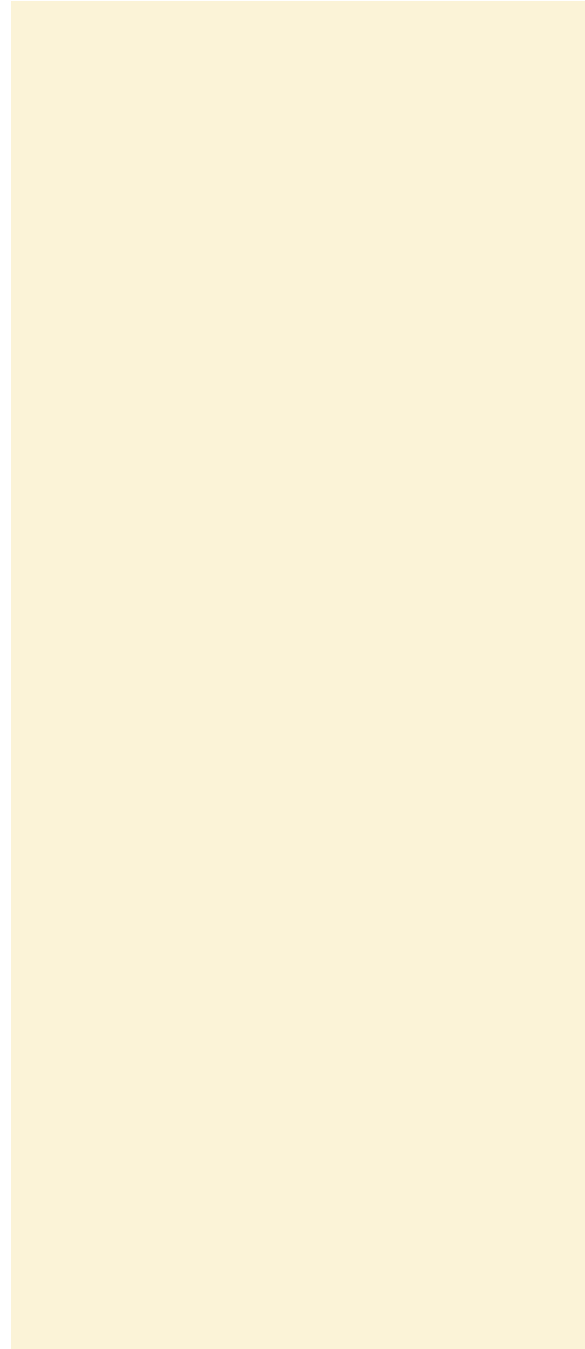

CHAPTER 3

DECISION SUPPORT IN THE SELECTION OF CONTROL SYSTEMS

3.1 Introduction

This chapter discusses whether a daylight responsive control system is useful in a given application. When it is concluded that a system is useful the next question is which system to choose. A decision table is presented that will guide the reader through this selection process. Only generic types of control systems are discussed here, because brand names and technical details of daylight responsive control systems change constantly with time due to continuous improvements and developments. The decision to install a control system has to be based on the overall lighting demands, the availability of daylight and energy constraints. This approach follows closely the normal design process. An important issue (but difficult to specify) in the design process is lighting quality. To most designers lighting quality means not just meeting the demands for visual performance (enabling the user to read text) but also creating an atmosphere (ambiance).

Most codes and standards present *minimum requirements* for lighting. These minimum requirements are based on safety and visual

performance. This could be a demand on the presence and dimensions of windows offering the occupants a view on the outside world or the specification of a minimum horizontal illuminance.

The *preference of the users* however might differ considerably from the minimum requirements. The users might prefer a room with windows not just for the view but also for the daylight that contributes to the illumination of the room. Moreover additional demands might be posed on the luminous environment such as higher preferred illuminances for the work surface, lighting of the walls, specific luminance ratios, colour rendering, etc. Furthermore users prefer to have control over the lighting of their working place.

The constraints on energy use and the available budget put a limit to what is achievable. Many countries nowadays have Compulsory Energy Performance Standards that place an upper limit on energy consumption.

This means we have to look for a solution that meets the user preferences, satisfies the relevant codes and is energy efficient. Daylight responsive control systems can help to achieve the energy efficiency but they also require an investment.

3.2 Is daylight responsive control feasible?

Whether there is any benefit in installing a daylight responsive control system depends on the lighting demands for a space and the daylighting conditions in that space. A number of economic aspects play a role. When a space is only used occasionally or the daylight availability is limited the costs for an automatic system have to be low to make it feasible. When the tasks to



be performed in that space are crucial and demanding then good lighting is essential. Sometimes the price of a control system might become less relevant. It is obvious that in any case the approach should be based on total cost of ownership.

Most countries have Compulsory Energy Performance Standards for buildings that place limits on installed power or on the efficiency of the lighting installation. A control system can help to meet these standards.

3.2.1 Lighting demands

The demands for the lighting from different parties involved, such as the building owner, facility management and the users of the lighted spaces can be different and sometimes even conflicting.

The required lighting conditions for a given application can be found in the local codes and standards applicable for the building.

The codes and standards generally offer minimum illumination values for the visual task(s) and concern only electric lighting. Daylighting is in most cases hardly discussed. In some countries a minimum daylight factor is specified, in other countries only the availability of an outside view is required. Additional criteria may be given for colour rendering, glare protection, etc. Other demands may deal with flexibility, which may mean that the lighting must be adaptable to different tasks and different users (for instance in a multiple user environment such as a sports hall) or it may mean that it allows adaptation of the space (moving partitions or

rearrangement of furniture).

The user preferences are mostly too subtle to describe in standards but are not less important. Sometimes codes or standards will give preferred conditions in addition to minimum requirements. In many places research is ongoing trying to establish preferred conditions.

With a lighting control system it is possible to adapt the electric light levels to the user's preferences (i.e. depending upon the actual visual task, preferably on individual basis).

Another aspect of functional flexibility of a control system is the ability of the system to react not only to external influences (weather...) but also to internal influences; i.e. local manipulation of the sun-shading, changes in furniture or decoration, ageing or breakdown of lamps/luminaires etc.

3.2.2 Daylight availability

The daylight availability primarily defines the building's potential to utilise daylight for energy savings (see Chapter 4). In an existing building (retrofit) the evaluation of the daylight availability can be done by measuring daylight conditions. In a building in the design stage there are several ways to predict daylight availability [ref.: Daylight tools]. These methods range from simple prediction of Daylight Factors (DF) by means of graphs to complex calculations and even photo-realistic visualisation software (e.g. Radiance).

Here are two rules of the thumb for the daylight condition in the room at overcast sky:

- If in the overcast sky condition half of the design illuminance is met by the daylight, a control system may be profitable.
- When there is too much daylight in the room, generally the demand for shading is so high that the system loses a big part of its efficiency.

Only when there is a significant daylight contribution one should explore the possibilities to use daylight responsive controls for the lighting. After the analysis of the daylight conditions a careful design of the electric lighting has to be made and an appropriate control strategy has to be selected.

The selection of a system is primarily based on economical criteria (investments and payback times). Sustainability is in many projects another important criterion. The easiest way to convince building-owners to invest in a particular system is to present an attractive payback period for their investment. There are two main sources for payback: reduction in energy costs and improvement in productivity of the workers in the building.

Factors influencing daylight availability in the building are listed below.

The **building site** defines the daylight availability at daylight openings, such as whether the building is free-standing or not, and whether there are external reflections of surfaces of ground and whether there is an influence of other buildings and the landscaping (high trees etc.).

The **orientation** of the facade is an important factor in the design of the daylight system. This

will determine the need for, or the influence of (venetian) blinds, screens and control (manual or automatic) for movable systems.

The **building height** is another factor. Strong shadowing by adjacent buildings, trees etc. occurs more often in the lower part of the building. So it can be interesting to install control systems only in the higher stories.

Glazing and presence of daylight-handling systems have an effect on the potential energy savings.

The use of low transmittance glazing reduces the amount of daylight entering the room and as a consequence the energy saving potential. But the low transmittance glazing keeps the heat outside, which is sometimes considered more important for the energy savings than the effect on the lighting.

The **room-depth** is an important factor. In rooms that extend deep into the building one can install daylight responsive artificial lighting control systems that handle just the peripheral zones.

It is clear that only a fully integrated daylight responsive control system will offer optimal energy savings and user's satisfaction.

Daylight through a clear window results in too high levels near the window and too low at a few meters distance; good daylight systems are expected to improve the distribution by reducing levels near the façade and raising levels further away.

After all, it is not necessary, nor possible in the concept phase of the building, to strive for very accurate calculations, because there are too many uncertainties in this phase. A simple approach can be sufficient for the decision to use daylight responsive control systems or not, while an advanced visualisation can be very

helpful for prediction of some comfort shortcomings with considered daylighting systems under well-defined daylighting conditions.

3.2.3 Electric Lighting System

Proper operation of daylight responsive control of electric lighting asks for a suitable lay-out and selection of lamps and luminaires. For dimmable control systems the lamps have to be dimmable. This is not the case for all lamp types. The widely used (compact) fluorescent lamps (with appropriate high frequency ballasts) are dimmable. Other types of discharge lamps that are sometimes used in uplighters cannot be dimmed (at present). Incandescent (also halogen) lamps are dimmable, but not recommended in combination with daylight linked control systems, because of their high energy consumption. New future halogen lamps may change this situation.

Lamp colours and colour rendering must fit; i.e. in case of a quick transition from predominantly natural light to electric light “colour perception shocks” have to be avoided, too low colour temperature of the electric lamps (i.e. incandescent) doesn't fit well with daylight.

High Intensity Discharge lamps are becoming more common in uplighters, sometimes also in downlights in office applications where the aesthetical effects, such as object- and accent lighting, are considered important. It is clear that in this case it is not a problem that the lamps cannot be dimmed, because daylight responsive dimming could destroy the desired effects.

In some applications it is not desirable that the artificial lighting varies under influence of a control system, i.e. accent lighting of exposed goods in warehouses or display-cases, blackboards in classrooms etc. In addition, in some industrial applications where the artificial lighting is used as an inspection tool (i.e. surface examining) automatic variations of this artificial lighting component must be avoided.

3.3 Which control system?

3.3.1 Control requirements

Since natural light can show very large and quick variations, i.e. in the case of cumulus clouds; the response time of the control system must be capable to follow these variations without becoming too agitated. In general a sharp decrease of daylight should be supplemented immediately by an increase of artificial lighting, whereas dimming of the artificial lighting (and switching off) should be done more smoothly. For switching systems the problem is to define the on-off hysteresis: too high hysteresis means illumination gaps or poor saving and too small hysteresis means agitated lighting.

The user acceptance of an on/off switching system is strongly dependent upon the climate, i.e. in regions with predominantly blue sky (Arizona...) where there is no risk for frequent disturbing switching. A typical unstable English weather condition can cause many problems. Even the orientation of the window can be

decisive when choosing for a switching or dimming system; i.e. the non-sunny side (North side in Europe) is much less varying than the sunny-sides and will offer far less problems in case of switching.

Constant-holder systems are designed to maintain the illuminance chosen, which should be conforming the indoor lighting standard.

A control system that is not linked to daylight is occupancy sensing. This may be especially energy effective in rooms with a low occupancy rate. One has to be very careful by using occupancy sensors; for safety reasons it should be ensured that the field of detection of the sensors covers the necessary space. Furthermore sudden on/off switching in the vicinity of workers can be very annoying to them (flashing effect). The use of more sophisticated occupancy sensors, switching on or off after a smooth dimming cycle, can be more convenient in an occupied environment. These systems are more expensive than the simple ones mainly because they need the use of dimmable lamps (ballasts). It is important to control both the natural and the artificial lighting, but in many cases the control of the daylight is done manually.

The possibility for the user to overrule the automatic control and the user interface are important for the general acceptance by the user. Good acceptance can even lead to enhanced energy saving; i.e. when the user uses the possibilities like manually overrule the lighting levels downward, or switching off the lighting etc. In case of very high natural light levels in parts of

buildings, i.e. atrium, good balanced and comfortable lighting asks for relative high levels in the adjacent zones. Users tend to prefer higher indoor light levels when there is more natural light entering the space, the use of so-called light level constant-holders may lead to a rather gloomy interior impression and too high contrasts with the window parts.

3.3.2 Economics

Reduction of energy cost is roughly predictable when there is enough information available about the selected daylight systems, the artificial lighting system, the applied control systems and the concerned building (see chapter 4). Reducing energy with daylight responsive controls is achieved by dimming of light sources based on the amount of available daylight. In this way also the energy load is reduced, resulting in reduced cooling energy costs and increased thermal comfort.

Installations can range from simple fixed group on/off switching or individual luminaire-based dimming systems to bus-like building management systems wherein the aspect "daylight responsive control" is just one of the many objectives, besides aspects like comfort, flexibility and prestige. Of course also the necessary investment as well as the operating costs will vary accordingly, but for the more sophisticated systems, it is hard to estimate which part of the costs can be attributed to the daylight responsive control function. In the case of the simple switching- or luminaire-based dimming systems, the daylight responsive system related costs are easy to estimate. One should be aware of the energy consumption of

some permanently operating control systems; this may cancel a part of the possible energy savings. For instance, a simple switching relay can consume a few watts.

Maintenance counts for an important part of the operating costs. In some (large) buildings the presence of skilled technical people can play a decisive role in the decision to choose for more sophisticated systems; they can keep the installations in optimum working condition.

Based purely on economics, in many cases, surely in smaller buildings, a very simple closed loop luminaire-based control system is a good choice; functional and simple to install and tune. In larger buildings a more complex group system or bus system can be considered. And also combinations of bus-based control systems with autonomous functioning luminaire-based controls are possible to apply.

The payback period depends on the energy saving and the cost of energy. Since the saving potential of a building is the sum of the saving-potentials of the different spaces in the building it can be interesting to choose different systems for different spaces in one building. For specific spaces of a building, for instance spaces with very limited daylight incidence (some internal corridors, cellars etc) and/or spaces with a limited occupancy-time it is not necessary to install a daylight-linked system. In those cases occupancy-linked control can be a good choice, in case of a low occupancy rate such a system will save energy and enhance comfort (no need to search for the light switch).

The climate and the presence of a cooling installation

can be a decisive factor in the use of a system. Lowering the peak- and average heat load of a building using a daylight responsive control system for the artificial lighting can lead to the choice of smaller cooling units and will decrease cooling energy costs. The importance of the cooling load reduction is strongly dependent of the type of building, the used cooling system and the climate.

The aesthetics or corporate image can ask for special systems or effects that have an impact on the cost of the system.

Some governments encourage energy savings by giving subsidies or tax-advantages for energy saving measures; of course, this reduces the payback-time for the investments. In general the electricity suppliers are able to give information about the subsidising possibilities and -procedures.

The approach of defining whether or not a system is feasible (as well as the question which system) can be different for **new** or **existing (retrofit)** buildings. For new buildings a simulation method by existing software can be used to predict the daylight availability by the calculation of daylight factors (DF) in the rooms as well at the peripheral zones as well as in the deeper parts of the building.

Existing buildings offer the possibility to define the saving-potential by measuring the daylight factor in some representative daylight situations.

As a rule of thumb one can say that a system can be useful if, measured during an overcast period $DF \geq 1\%$. Unlike for new constructions, it is possible to measure the existing conditions and use the result to support the decision-making.

Some maintenance programs and facility

management policies tend to interfere with the effectiveness of daylight systems. For example there is a policy to close the blinds every night. In practice it is noted that closed blinds are left closed during the daytime after the occupants return.

The choice of a certain daylight responsive control system, supposed that all considered control systems give satisfaction on ergonomic- and legal demands, is mainly based on economical reasoning. This means the highest benefit / total cost ratio will probably be the best choice. However, as already mentioned above, certain extra possibilities, as there are in some cases for remote control, scene pre-set possibilities, group configuring possibilities, integrating facilities for control HVAC or integration in existing BUS systems can influence the choice. Also the possibility of retrofitting the existing luminaires can influence the choice.

note:

Although the “relative” energy saving potential figures through daylight application, combined with daylight responsive controls for the electric lighting, can look attractive on the first sight one has to consider that generally (expressed in absolute amounts) the saving potentials on actual optimised artificial lighting installations are rather small. This due to the fact that these actual installations, i.e. in offices, consume generally no more than 10-12 W per square meter. Without tax-advantages and/or subsidising the payback time of some more complex controls can be too

long. Of course, as already mentioned above, energy saving is not always the only goal.

3.3.3 Ergonomics

As a general rule one can state that, whatever system is used, it will only be accepted when the functioning of it is understandable, or even better, unnoticeable for the user. If not accepted by the user systems will be sabotaged and not lead to increased comfort and energy savings.

The acceptance by the users is influenced by the task they have to perform. For the more demanding tasks, that require concentration, less distraction from the lighting (switching lights, clicking relays or noisy blind movements) will be tolerated.

The need for constant adjustment of the lighting to customise it to a particular task or user seems to negate the need for daylight responsive control systems. But the more complex systems can offer various user interface possibilities; i.e. over-rule possibilities for dimming/switching the artificial light or the sunshading/daylight system. It is extremely important that these functions are clear and simple to the user. The same counts for reconfiguration and adaptation of the more complex systems, at least in (smaller) buildings where there is not a skilled technician permanently present.

The simple luminaire-based daylight responsive control systems generally ask no special trained people, because user interface mostly is limited to the control of the luminaire’s dimming threshold.

Improvement of productivity in a better-lighted and more agreeable working environment, although generally

accepted, is difficult to measure. Other issues, beyond the scope of this application guide, include user comfort and corporate image.

It is important to understand the interrelationship between the preferences of users and energy savings. Experience has shown that user comfort and acceptance are critical for generating energy-savings. For instance, a free-standing highly glazed building can potentially have a lot of daylight. However, without appropriate glare control as part of the daylighting system, occupants will keep the shading closed and potential energy savings from the use of daylighting controls will be lost. Distraction caused by noisy motors or dramatic switching on and off of lights can also lead the occupants to disable systems.

It is good to realise that energy-costs in professional working environments are just a very small portion of the total cost or even of the total labour cost. A non-happy worker who's productivity decreases for a few percent can neutralise quickly a lot of efforts made on energy-saving on lighting; this in addition to the above already mentioned possible systems disabling actions. On the other hand a good lighting design with the appropriate lighting controls can help to create a pleasant working environment in which the productivity is enhanced.

Offering a good comfortable and ergonomic environment, adapted at the specific function of the building (or space) therefore offers the largest benefit.

The user's tolerance for variations in artificial lighting, i.e. sudden variations of intensity or colour, glare,

contrasts etc. is rather small compared by the user's tolerance for the natural light. Therefore control of the electric lighting must function in such a way that it ensures maximum energy saving and at the same time guarantees a "good lighting" (level and distribution) under all circumstances of daylight incidence, no matter whether this incidence is influenced by external- or internal parameters.

3.3.4 Decision table

From the previous discussion it is clear that the selection of a control systems will be based on multiple criteria. Some of these criteria may be quantified. Other criteria however (such as sustainability) are less easy to specify or even subjective (such as 'image' added to a building).

Here the focus will be on those criteria that can be evaluated.

The selection is summarised in a so-called Decision Table (table 3.1) that should guide the decision process. This table is based on the results of the test conducted by the Subtask B participants. The selection follows more or less the line of the discussion in this chapter. It is based on seven criteria. The first three conditions 'Daylight availability', 'Suitable shading device', and 'Suitable electric lighting system' are the main exclusive conditions. Their values should all be 'Yes'. The fourth condition 'Building management system for lighting' checks whether a BUS-system is available in the building to control the lighting conditions centrally. If the answer is 'yes' open loop control systems are probably the best (cheapest etc.) choice; although it is also

Design Level: The desired illuminance on the work surface (e.g. 500 lux, 750 lux, 1000 lux...) will influence the amount of energy needed and therefore the cost. As a rule of thumb one can say that application of daylight responsive control systems are not interesting for design levels below 300 lux, unless there's an important subsidy policy (see below).

Rules of thumb can be used; i.e. if $DF \geq 3\%$ for the most efficient zone (daylight zone) and $DF > 1\%$ for the intermediate zone the use of a daylight responsive control system for artificial lighting can economically-based be considered (taken in account the energy-cost).

possible to have autonomous operating luminaire or room based closed loop systems operating "under" a bus system. With an open loop control system it is also possible to integrate the lighting control with other indoor climate functions. If the answer is 'no' the following conditions determine the 'Number of people' in the room, the average 'Time of occupancy' of these people, and the 'Required illuminance'. The answers to these questions determine which control systems can be selected. What is not taken into account in this table are the comfort needs of the people. These also will influence the choice of the control system.

Daylight availability	yes										no				
Suitable shading devices	yes										no		-		
Suitable electric lighting system	yes										no		-	-	
Building management system for lighting	no										yes		-	-	-
Number of people	1					2 or more					-	-	-	-	
Time of occupancy	short		long		irreg-ular	short		long		irreg-ular	-	-	-	-	
Required illuminance	< 400	>= 400	< 400	>= 400	-	< 400	>= 400	< 400	>= 400	-	-	-	-	-	
Closed loop, room based,		x	x	x	x										
Closed loop, luminaire based		x	x	x	x		x	x	x						
Open loop, building based											x				
Open loop, room based											x				
Occupancy on/off		x		x	x										
Occupancy dimming		x		x	x		x	x	x						
Possibility to integrate with other functions											x				

CHAPTER 4



PREDICTION OF ENERGY SAVINGS AND COSTS

This chapter will explain the reader how to estimate the benefits from daylight responsive control in terms of possible energy savings and costs. The objective is to explain how the reduction of energy use for electric lighting by means of daylight responsive control can be estimated/calculated.

First a general introduction to this topic will be presented. Then some methods will be described in detail. In these technical sections the advanced topics are:

- TU Berlin method for estimating potential energy savings:
- Estimating the amount of available daylight in a given room: the room potential
- Estimating the amount of energy that can be saved by a given type of control system: system potential
- The characterisation of the performance of daylight systems. The amount of daylight that is brought into a room without reduction of visual comfort is an important factor in the possible energy savings
- Statistical method of energy saving prediction based on measured daylight frequencies
- Characterisation of control systems in a laboratory test facility
- Evaluating control systems in a scale model test facility

4.1 Introduction

When talking about the saving of energy, first one has to define what kind of energy can be saved when implementing a daylight responsive lighting control system. The energy consumed in a building can be classified into different types, see figure 4.1. The electric energy expended for artificial lighting can be saved with intelligent control systems. But there is some interaction between these different forms of energy, e.g. saved energy for lighting has an impact on the necessary cooling or heating energy in the building, see figure 4.2. This can signify that the cooling loads can be reduced when the lighting is controlled or on the contrary that the necessary heating energy is increased. Therefore the prediction of energy savings by utilisation of daylight through control systems should not be treated isolated from the thermal environment. The thermal aspects of lighting can positively or negatively affect the entire resulting energy saving potential.

Although an overall energy reconsideration is necessary when making an exact prediction or calculation of the (overall) energy savings created by control systems, there exist some simplified methods to assess the saving potential. In this chapter some of the most important procedures to make estimations of the possible energy savings by daylight responsive lighting control use are presented and explained. Most of them consider the direct energy saving potential neglecting the thermal aspects.

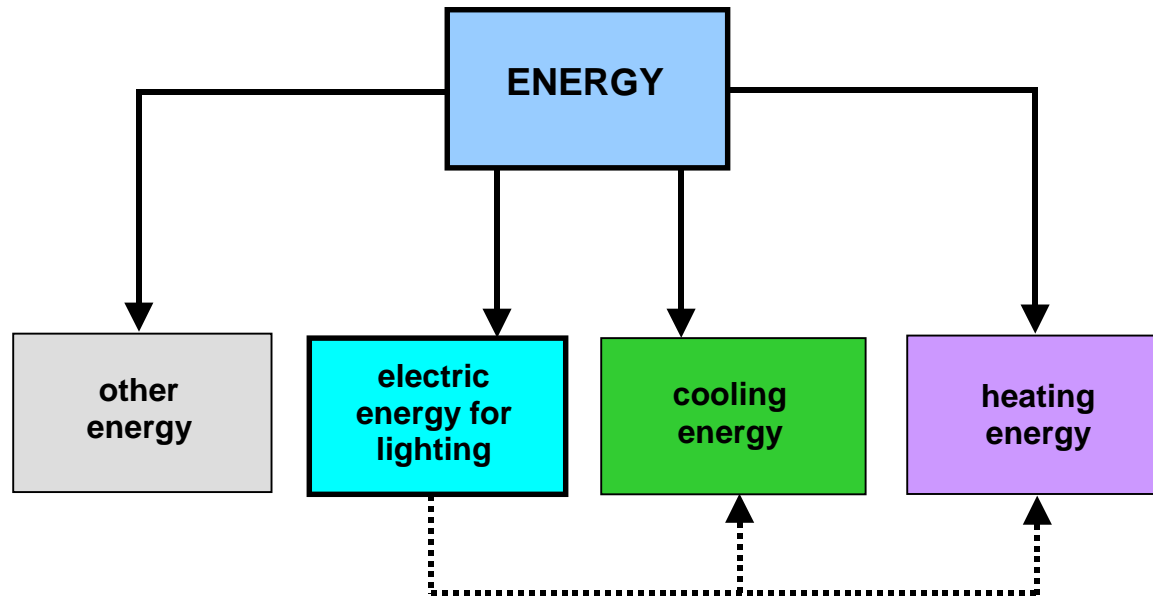

Figure 4.1. Rough classification of the energy used in buildings. Three major parts are the energy flows needed for lighting, heating and cooling. The amount and kind of 'other energy' depends on the use of the building.

In the discussion of control systems and their expected energy savings the aspect of time has to be considered too. With increasing time in which a lighting control system is in use, the absolute amount of saved energy and therewith the saved costs for electric lighting will increase.

The question that comes up now is, at what time the regarded control system will have been paid back by the energy savings, because a short pay back time means a monetary advantage to the building owner, who decides whether to install a

control system for artificial lighting or not. To assess the monetary savings of a control system not only its effectiveness has to be considered, also the investment cost, the installation cost and the operating cost are relevant criteria, see figure 4.3.

In order to compare systems with regard to their effectiveness, the most important thing to consider is the building, e.g. the room in which a control system will be installed. The regarded control system in combination with the building in which it should be applied has to be treated as a unit, in which besides

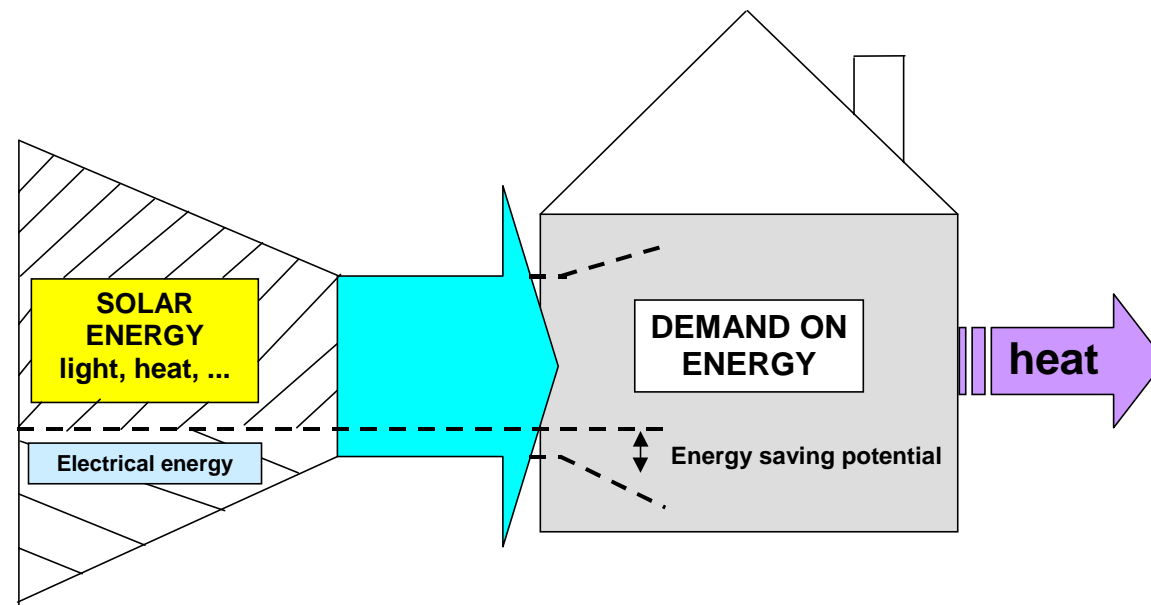

Figure 4.2 Energy flow into the building and energy saving potential

the system's property the amount of usable daylight influences the effectiveness.

As shown in this introduction, the topic of the energy saving potential is multi-dimensional, but the following techniques will help to facilitate the analysis and the decision process.

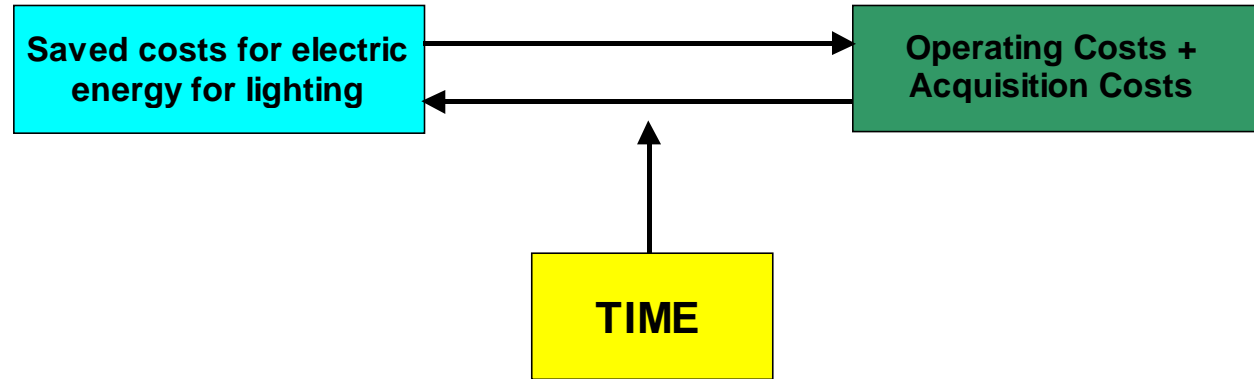

Figure 4.3 Time as a relevant factor determining the relationship between the costs and the saved costs by energy savings.

4.2 Frequency method to predict direct savings from daylight responsive controls

This method is meant to give a quick estimate of the energy savings from daylight responsive control systems. As this is a simplified method complex factors such as the reduction of cooling load (depending on heat storage in the building) cannot be taken into account.

To estimate the possible energy savings from

daylight responsive controls a number of steps have to be made. The actual calculation depends on the system(s) used. The ideal system will maximise the amount of daylight in the room (within the acceptable luminance ratios) by adjusting the daylight system and supplement just enough electric light to meet the requirements. In order to see how an actual system performs a calculation has to show the theoretical maximum savings, so the energy the real system uses can be compared with this result.

In the simplified method the control characteristics

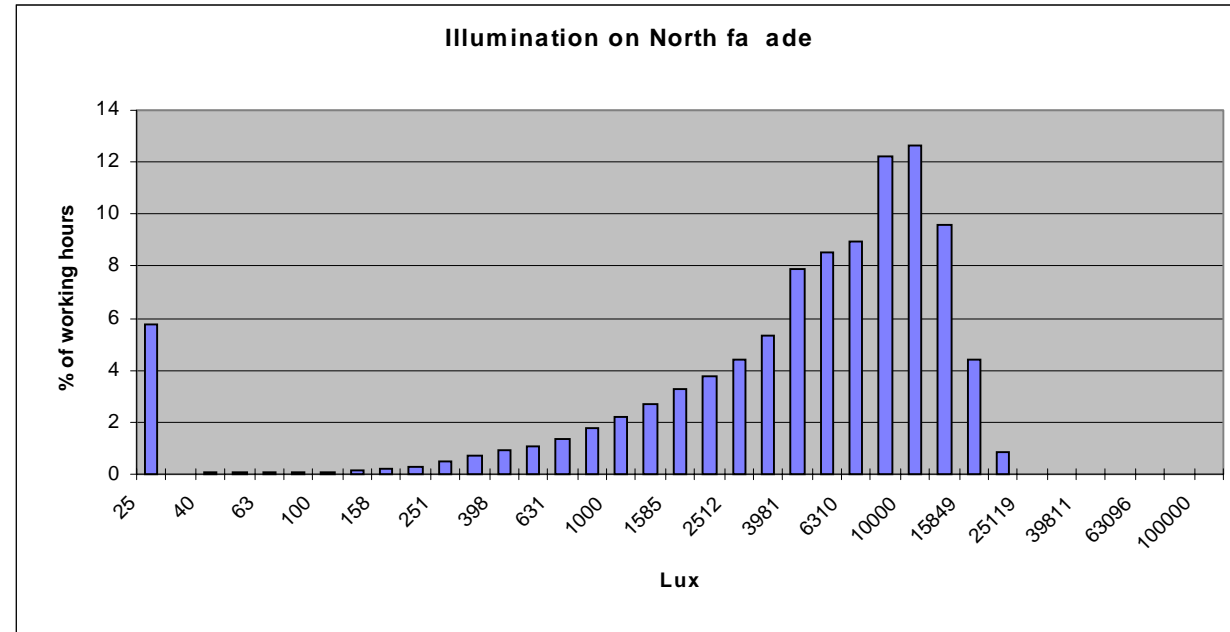

Figure 4.4 Sample frequency distribution of the illuminance on a North oriented facade in the Netherlands.

of the system are evaluated under a number of sky conditions. Most actual sky conditions can be described sufficiently accurate for this purpose as a linear combination of a limited number of theoretical skies. The results of this evaluation are then to be extrapolated to estimate the annual savings. This extrapolation (site dependent) has to be based on climatic data (for instance IDMP data). The validity of the extrapolation depends strongly on the type of control.

In a given room different solutions for the

daylighting system and the electric lighting system are possible. The most important requirement of daylighting systems in a working environment is that they must enable the user to exclude any direct sunlight (shading).

Often the shading is controlled manually, so assumptions have to be made about the way the shading is set by the occupant. This can be very tricky as the behaviour of users can differ enormously. Generally speaking, people tend to close the shading to get rid of disturbing luminances and forget to reopen

it after the cause of the disturbance has vanished. It is clear that the selection of the shading and its control are the key factors in actual energy savings. In rooms without direct sunlight (North/South facing - depending on the hemisphere or any obstruction) often no shading system is necessary, but brightness control remains important. To give some insight in the factors influencing the energy consumption the calculation is split into several factors and can be performed by the aid of a computer.

4.2.1 Reference situation for energy use

In order to make comparisons the considered room with the same lighting installation but without any daylight responsive lighting control is taken as a reference case. It gives the energy used when no form of lighting control is installed. Furthermore it is assumed that the electric lighting is used during working hours with 100 % light output. In many offices without any daylight responsive control system for the artificial lighting, normally the light is switched on in the morning and remains switched on during the whole working day regardless of available daylight. Of course manual switching (preferable in zones related to the daylight distribution in the room) can be a profitable strategy to start saving energy.

4.2.2 Electric lighting

In this paragraph only the electric lighting is discussed. The effect of the daylighting system will be calculated separately.

In most cases for daylight responsive electric lighting control the sensor is ceiling or luminaire mounted and looking downward to the working plane. In a limited number of systems the light sensor is located outside the room, either in a reference room or elsewhere in the building or mounted on the roof or on the facade.

In the case of a ceiling mounted sensor the sensor measures the luminance within its field of view. Based on the sensor position and the opening angle of the sensor the area "seen" by the sensor can be determined. Then it is necessary to know what (i) luminances occur on this area in practice (see figure 4.5). This can be determined sufficiently accurate by using a daylighting computer program such as SUPERLITE which is part of the Adeline 3.0 package also developed within IEA task 21. The calculation has to be performed for a CIE overcast sky and a uniform sky. For rooms with possible direct sunlight the effect of a shading system has to be calculated separately (see below).

From the calculated illuminances and the characteristics of the system the relation between the daylight levels in the room and the energy use of the system is known and can be used to estimate yearly values.

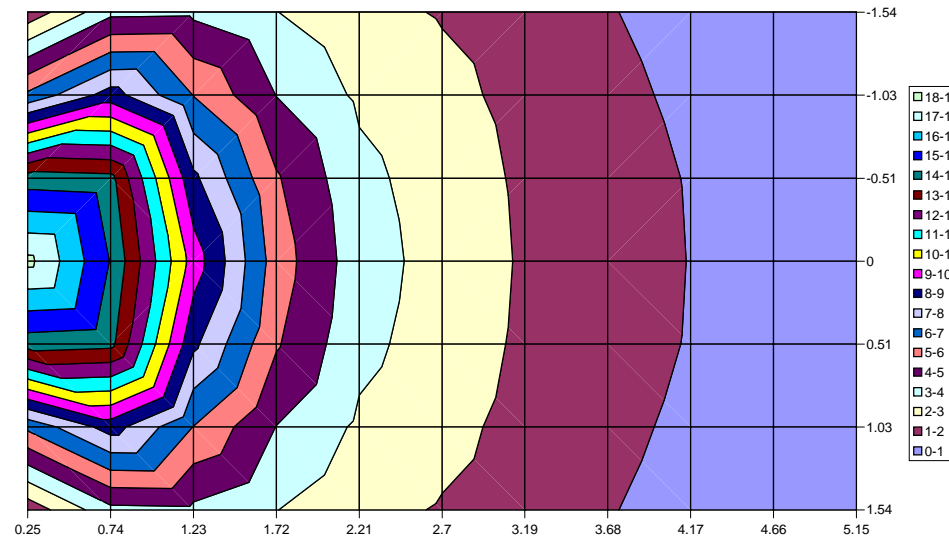

	1.54	1.03	0.51	0	-0.51	-1.03	-1.54
0.25	1.34	6.22	14.48	18.28	14.48	6.22	1.34
0.74	3.72	8.46	14.29	14.94	14.3	8.46	3.72
1.23	3.79	5.97	8.22	9.53	8.22	5.97	3.79
1.72	3.02	3.98	5.1	5.5	5.1	3.98	3.02
2.21	2.29	2.83	3.27	3.44	3.27	2.83	2.29
2.7	1.93	2.28	2.53	2.63	2.53	2.28	1.93
3.19	1.55	1.71	1.84	1.89	1.84	1.71	1.55
3.68	1.02	1.09	1.15	1.17	1.15	1.09	1.02
4.17	0.87	0.93	0.98	0.99	0.98	0.93	0.87
4.66	0.87	0.93	0.98	0.99	0.98	0.93	0.87
5.15	0.83	0.88	0.92	0.93	0.92	0.88	0.83

Figure 4.5 Step 1, Estimate of the average luminance/ illuminance registered by the sensor (red circle). The average daylight factor is 6%. At 10000lux exterior illuminance and with a reflection of 30% the luminance will be 58 cd/m²

Step 1 see figure 4.5

Step 2 Calculate optimal energy savings from an ideal control system

Based on the “ideal” control system. This is a hypothetical control system controlling the same installation that will always supplement with artificial light up to the minimum desired lighting level and switches the electric lighting off when there is enough light from daylight only. Such a system is not (yet) available on the market. The calculation is based on the same daylight data as used in step 1. The switching of electric lighting can be a very disturbing effect.

Step 3 Calculate savings from a real control system

In this case the control characteristics of the system have to be known. These characteristics can then be used to calculate the estimated energy savings as described.

4.3 Calculating the energy saving potential

4.3.1 TU Berlin method for describing and predicting the energy saving potential

At the Institute of Electronics and Lighting Technology, Technical University of Berlin, a method has been developed to calculate the possible energy savings by the use of daylight responsive lighting control systems in buildings. The effective use of

the given daylight in buildings in combination with daylight dependent lighting control systems means a possibility for saving electrical energy, i.e. the minimisation of energy consumption of the artificial lighting. The energy saving potential is the maximum amount of energy that can be saved when installing a daylight responsive control system in a particular room with a certain electric lighting system. Its calculation can be divided into two parts: the room potential and the system potential /6,7,8,9/. The procedure works with the concept of the average sky condition model as a basis in order to characterise the daylight availability in the room /1,2/.

4.3.1.1 Room potential

The room potential in general describes the availability of daylight in the room. It is assumed that the lighting design is done properly. The room potential is influenced by the following parameters:

- geographical latitude
- local daylight availability (referring to the meteorological data and the average sky condition)
- daylight system (if installed)
- building, room and window properties (reflectance of the walls, the ceiling and the floor, geometry, window size and orientation of the glazed area, obstruction, etc.)
- the working time
- the design illuminance E_s

The calculation of the room potential considering all aspects and referring to the average sky is relatively complex, therefore it can be calculated with a computer programme, for instance *Easydays*

energy saving potential =
room potential x system
potential

(available at PRC, Berlin Germany). The room potential is based on the relative usable light exposure, describing the daylight availability, which will be discussed in the next paragraphs.

4.3.2 Availability of daylight

The amount of usable daylight in the building interior mainly depends on:

- The sun position (angles of azimuth and elevation), that can be derived from the information about the geographical latitude of the building and the exact time and date.
- The sky condition (e.g. cloudiness, direct sunshine or not, type of clouds etc.)
- The turbidity of the atmosphere, which depends on the height of the place above sea level and the aerosol and vapour content of the atmosphere.
- Obstruction and its properties (dimensions, reflectance)
- Ground reflectance

The sky condition is important for the assessment of daylight in interiors. Obviously, the momentary sky condition is not very useful for the estimation of the energy-saving potential for a long period of time. In this case, the long term average of daylight data is needed. Therefore the German standard introduced the average sky type /1/.

4.3.2.1 Relative usable light exposure

If the electric lighting level can be adjusted by

dimming, the economical benefits by using the available daylight depend on the annual relative usable light exposure $H_{use,A,rel}$. The annual relative usable light exposure is the ratio of the total annual daylight exposure in the room and the required total light exposure, which can be calculated with /3,4/:

$$H_{use,A,rel} (\%) = 100 \cdot (\sum N_i \cdot (\int E_p \cdot dt)) / (E_s \cdot t_w \cdot N_A)$$

with

N_i	: Number of working days per month
N_A	: Annual number of working days
$t_w = T_E - T_B$: hours of daily working time
T_B	: Begin of the working time (e.g. 9 ⁰⁰ LCT, Local Clock Time)
T_E	: End of the working time (e.g. 18 ⁰⁰ LCT)
E_p	: daylight illuminance at a point in the interior
E_s	: the design illuminance

The equation holds only for values of E_p (daylight illuminance) $\leq E_s$ only. For $E_p > E_s$ one has to calculate with $E_p = E_s$. The usable light exposure can be used to describe the part of the artificial lighting that can then be replaced by the available daylight. The room potential is the mean annual relative usable light exposure over the room area A.

$$H_{use,A,rel, average} = (\iint H_{use,A,rel} dA) / A$$

For more details see /1,2/.

4.3.2.2 System potential

The system potential has to be assessed by measurements or derived from data supplied by the manufacturer. The system potential is mainly influenced by the way of the daylight dependent control of the artificial lighting:

- daylight dependent switching
- daylight dependent dimming
- daylight dependent dimming with respect to the room depth
- open or closed loop control strategy

At the Institute for Electronics and Lighting Technology the system potential of a daylight dependent lighting control system can be measured in combination with daylight systems under various sky conditions. The measurements take place in test rooms that are equipped with some control systems.

4.3.4 The average sky condition

The CIE described standard sky types for overcast and clear sky and gives formulae how to calculate the data. But most of the time these sky types do not occur in their pure form, often the sky is partly clouded. The average sky can be calculated from the daylight data for overcast and clear sky. The local sunshine probability P_{sun} has to be taken into consideration. P_{sun} is the ratio of the actual long term sunshine duration and the possible sunshine duration.

In working areas direct sunshine is usually not very useful because of glare, heat and too high contrasts. Because of the large differences between direct sun light and diffuse sky light, the components of the resulting light (the illuminance of the average sky) have to be calculated separately. Therefore the diffuse and the direct components of the solar radiation and the daylight data on average sky conditions must be calculated separately according to the local sunshine probability, i.e. one calculates the part for the time interval with sunshine and for the time interval without direct sun according to P_{sun} . In /1/ a detailed description of the German average sky is given. In /1/ and /2/ the calculation of the relative usable light exposure on the working area in dwellings according to the average sky is explained.

4.4 A simplified method to characterise the efficiency of daylight systems

4.4.1 Introduction

The actual savings on electric energy that can be achieved by the use of daylight responsive control of electric lighting are determined by the amount of daylight in the room. This amount of daylight is strongly dependent on the properties of the shading and/or glare protection system. Some opaque types of shading may fully block the daylight while other systems (even in a closed position) will bring some of the daylight in the room through deflection and or diffusion. An essential criterion to observe is the visual

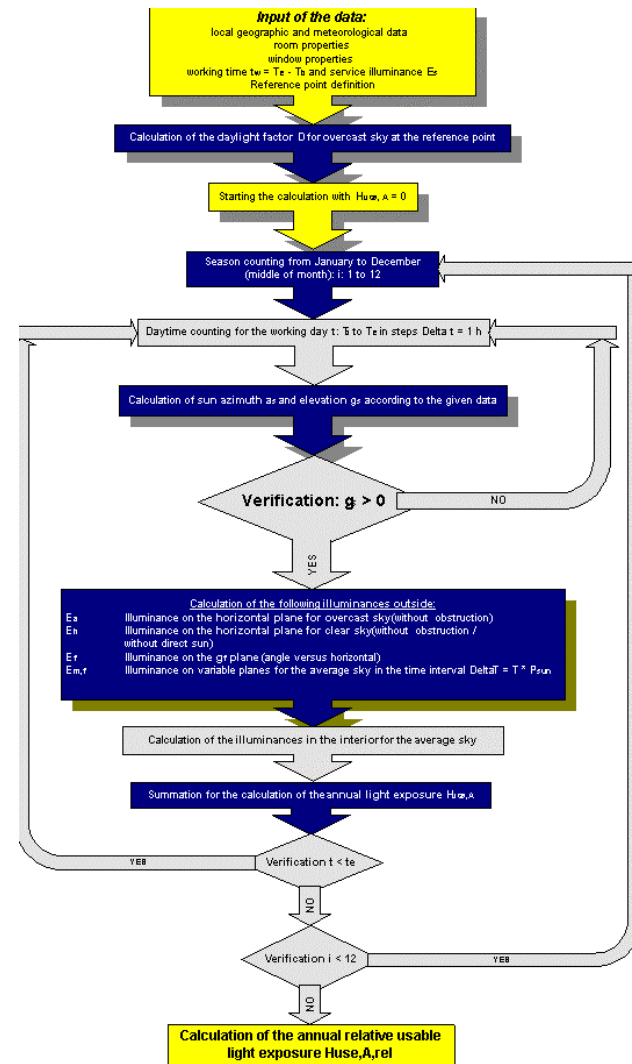

The flow diagram gives an overview about the steps how to calculate the annual relative usable light exposure related to a reference point in the office with side windows /2/.

comfort of the user. So in this method we compare systems under several sky conditions in order to see how efficient they are in bringing daylight into the room without glare for the user.

The efficiency of a daylighting system may be defined as the amount (total flux) of daylight entering the room without causing glare or annoyance for the user(s) of the room. As this involves many parameters a complete description is too complex to give in the context of this guide. More information on this can be found in the Source Book of Subtask A /see Further Reading/. What can be demonstrated here is a simplified method for the comparison of daylighting systems that can be used to estimate the energy performance of the overall lighting system.

This simplified method may be used to compare the influence of passive daylight control such as curtains, venetian blinds in fixed positions and other daylighting or shading systems. The comparison is dependent on the sky conditions (sunny, overcast, etc). It shows the effect of the daylight system on the total amount of daylight entering a room. The method does not look at the spatial distribution of daylight. When more daylight is entering a room the possible energy savings will increase (if the visual comfort is good).

Furthermore the method described here is based on the most relevant comfort parameter. This is the average luminance seen in the direction of the window. It does not take other factors into account. Other luminances resulting from incident daylight and reflections (such as ceiling luminance) sometimes play a role.

This method offers a simple first order check that needs to be extended for complex systems. This is necessary for those systems using one or more specular

reflections of direct sunlight. Sunlight cast towards the walls or ceiling may give rise to unacceptable high luminances.

It is important to note that the criterion given here is just a measure for the amount of daylight. If the daylight creates an uncomfortable or otherwise wrong luminance distribution, or if the room surfaces are so dark that no light is reflected, the daylight will not contribute to energy savings.

4.4.2 Calculation method

The approach followed here is based on the condition of the maximum luminance of shading and on the acceptable contrast ratio between the task luminance and the (background) luminance of the shading. Given a certain background luminance, it may be measured against the amount of daylight the system brings into the room.

For instance for VDU work the typical task luminance is in the order of 100 to 200 cd/m². This kind of task therefore permits a background luminance in the order of 1000-2000 cd/m². Several shading systems exist that are able to control the window luminance within this range. The amount of daylight that is entering the room however may differ considerably between these systems.

The criterion proposed here to describe those differences is the ratio of the average window luminance and the total luminance of all surfaces of the room.

4.4.3 Explanation of the calculation

To be able to compare a large number of elements the geometry is kept very simple. The characterisation process of a the daylight systems is done as follows:

Given a black room (no surface reflections, so no interreflections) with only one vertical window through which the daylight can enter the room

The total flux of daylight entering the room is equal to the sum of all the illuminances on all the surfaces in the room. This can be expressed in the form of an equation as:

$$\Phi = \sum E_i \Delta\sigma_i$$

This is the sum over all surface elements of the illuminance times the area of the element.

When a perfectly diffusing screen covers the window emitting daylight in all directions, the flux from the window into the room can be calculated as:

$$\Phi = \sum E_i \Delta\sigma_i$$

dA = area of screen (window) surface

L = average luminance of the surface

For a box of unit dimensions (1m x 1m x 1m), with a window on one side (of 1m x 1m) the equations may be simplified to:

$$\sum E_{i,average} = \pi * L$$

If we define the Daylight Efficiency of the daylight system as

$$DE = \frac{\sum E_{i,average}}{(\pi * L)} = \frac{\text{sum of average surface illuminance}}{\text{window illuminance}}$$

Then, in the case of a perfect diffuse emitting window surface:

$$DE = \frac{\sum E_{i,average}}{(\pi * L)} = (\pi * L) / (\pi * L) = 1$$

For surfaces with other transmission types other ratios will be found. Generally when the ratio is greater than 1 the system will bring more daylight into the room than the diffuse screen. When the ratio is less than 1 the situation is worse.

The given correlation can be verified by calculation. A preliminary test with Radiance (for a diffuse screen) showed good agreement between the results.

The calculation of this factor allows for the comparison of different daylight systems. Other tests are currently being developed to determine how to apply light-shelves, venetian blinds and daylight redirecting systems. This method can be used both in theoretical calculations using simulation models like Radiance as well as in laboratory measurements. In the latter case data from for instance integrating sphere measurements have to be used.

4.4.4 Examples

In the examples (table 4.1) a number of sample Radiance calculations are given. As the result for the systems that change the direction of the daylight as a function is dependent on the sky conditions calculations have been made both for overcast and clear conditions.

4.4.5 Results and conclusions

The results presented in the two graphs show that this method can be used to characterise the performance of daylighting systems. It is clear from the results that the performance is dependent on the sky conditions. As most problems in the visual environment occur for clear skies with direct sunlight this is the most relevant evaluation.

Some examples (light shelves, open window) are not realistic for clear sky with direct sunlight as the direct sunlight can enter the box and give rise to high luminances.

A general conclusion is that vertical elements perform better for overcast conditions while the horizontal systems are more suitable for sunny skies. This is because the direct sunlight is directed out of the line of view (towards the ceiling) while the luminance of the blinds in the horizontal line of sight is acceptable.

For the vertical blinds with 20% transmission the ratio of luminance versus transmitted flux is less favourable. The method presented here can be used to give a rough comparison between daylighting systems that cover a whole window. It does not give useful results for elements that often form part of a shading strategy such as light-shelves.

Name	Description
Clear window	Window without shading
Diffuse window	Perfect diffuse surface, e.g. screen
Lightshelf	Interior lightshelf with diffuse surface
Hor. - Dark – 0 deg.	Venetian blinds dark surface - horizontal position
Hor. - Dark – 15 deg.	Venetian blinds dark surface - tilted 15 degrees towards outside
Hor. - Dark – 30 deg.	Venetian blinds dark surface - tilted 30 degrees towards outside
Hor. - Dark - 45 deg.	Venetian blinds dark surface - tilted 45 degrees towards outside
Hor. - Dark - 60 deg.	Venetian blinds dark surface - tilted 60 degrees towards outside
Hor. - Dark - 75 deg.	Venetian blinds dark surface - tilted 75 degrees towards outside
Hor. - Light - 0 deg.	Venetian blinds light surface - horizontal position
Hor. - Light - 15 deg.	Venetian blinds light surface - tilted 15 degrees towards outside
Hor. - Light - 30 deg.	Venetian blinds light surface - tilted 30 degrees towards outside
Hor. - Light - 45 deg.	Venetian blinds light surface - tilted 45 degrees towards outside
Hor. - Light - 60 deg.	Venetian blinds light surface - tilted 60 degrees towards outside
Hor. - Light - 75 deg.	Venetian blinds light surface - tilted 75 degrees towards outside
vert. 20% trans - 0 degr	Vertical blinds with 20% transmission - closed
vert. 20% trans – 15 degr.	Vertical blinds with 20% transmission - opened 15 degrees
vert. 20% trans – 30 degr.	Vertical blinds with 20% transmission - opened 30 degrees
vert. 20% trans – 45 degr.	Vertical blinds with 20% transmission - opened 45 degrees
vert. 20% trans – 60 degr.	Vertical blinds with 20% transmission - opened 60 degrees
vert. 20% trans – 75 degr.	Vertical blinds with 20% transmission - opened 75 degrees

Table 4.1 and figures, *Overview of example calculations*

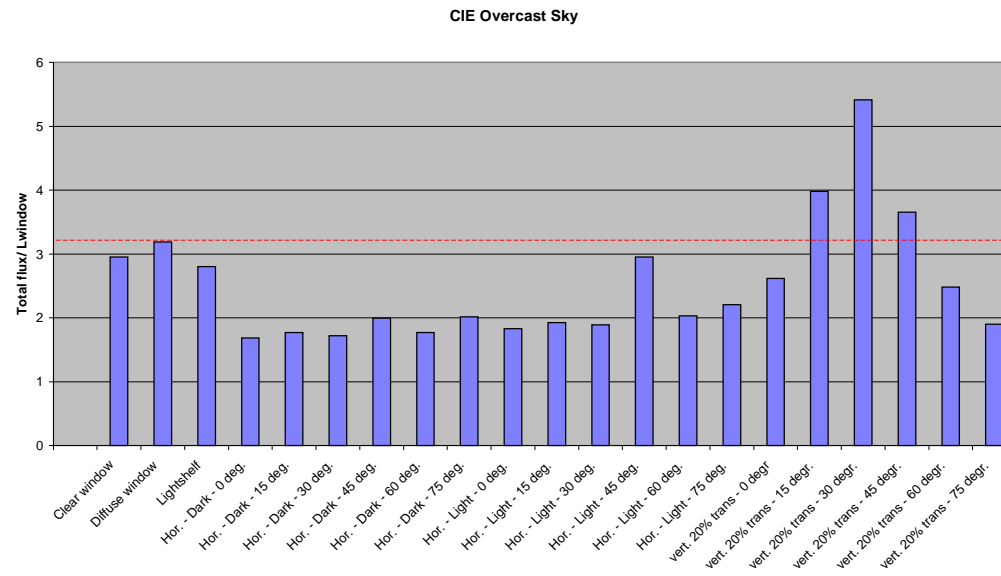
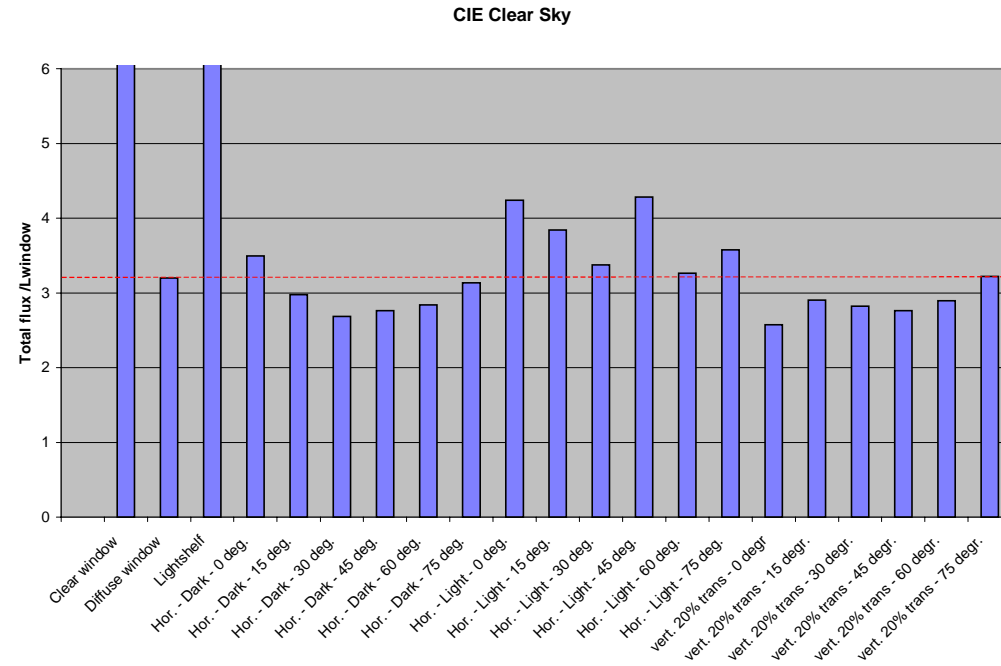

The results can be based on calculations but also on laboratory experiments using an integrating sphere for the flux measurement and a luminance meter to determine the average luminance of the element.

4.5 Laboratory Test Methods - Daylighting Box

The daylighting box is an experimental set-up to measure the performance of various sensor-controlled luminaires. Its results should be reproducible anywhere in the world. The set-up measures three items:

- (1) Characteristic of control. When daylight is increased how much does the controller adjust the artificial light? When daylight is increased what is the reduction of energy use (in watts) by the luminaire?
- (2) Range of control. What is the range or maximum and minimum setting of the controller (in lux)? Is the adjustment continuous or stepped through the range (e.g. 300, 500 and 750 lux)?
- (3) Responsiveness. What is the time delay between daylight changes and changes to artificial light levels?

4.5.1 Experimental set-up

The set-up consists of 2m x 2m x 2m cube that represents the space above a typical office desk that is lit by a single luminaire. The test luminaire is centred in the top plane of the cube (the ceiling).

An illuminance sensor is placed in the centre of the lower plane of the cube (the work surface). The vertical planes of the cube represent the wall surfaces. All interior surfaces in the cube are painted a matte medium grey colour (reflectance factor of 0.38).

One wall has an opening representing a window that extends from floor (worksurface level) of the cube to approximately 10 centimetres below the ceiling. Attached to this opening is a daylight simulator. The daylight simulator is designed to reproduce a range of daylight levels found in an overcast sky. The simulator consists of a bank of 27 daylight lamps arranged parallel to one another. The lamps do not shine directly into the room. Instead, they are directed at a surface that bounces light back into the room at a 45 degree angle. This helps to distribute the light evenly.

A computer controls the testing. This is important because the temperature of the lamps must be stabilised first before lighting measurements are made. If the temperature is not stable the output of the lamps will vary. The computer records the temperature of all the lamps in the experiment on one-minute intervals. When the difference between temperature measures is small enough the computer takes a lighting measurement.

The temperature of the testing environment is controlled. The daylighting box and simulator are located inside a laboratory room. The temperature inside the daylighting box generally matches that of the laboratory room in which it is located. Within the daylight simulator ventilation is provided across the surface of the lamps to prevent the introduction of heat into the test cube. Since the ventilation for the

daylight simulator exhausts into the laboratory room, the overall temperature in the laboratory room can rise a few degrees during testing (when the daylight lamps are on). To compensate for this, the laboratory room is mechanically cooled as necessary to maintain a constant temperature.

4.5.2 What is recorded?

During a typical test cycle “daylight” is gradually increased from zero to a maximum of 4000 lux. During this test cycle the following is simultaneously recorded: energy use by the ballast, illuminance level at the controller, light output of the daylight lamps, light output of the luminaire, and illuminance at the worksurface.

4.5.3 Evaluations

The artificial light versus the daylight and the power of the ballasts (watts) versus the daylight (energy use) are evaluated.

4.5.4 Application

This test method is appropriate for establishing the physical performance of various daylight sensor-controlled lighting systems, the results can be used to calculating potential energy savings. It is not appropriate for predicting user

acceptance, maintenance, or durability of systems.

4.6 Scale model testing of daylight responsive lighting control systems

The testing of lighting control systems generally requires a complex and large measuring system, including a 1:1 realistic test room with dimensions of an average office room. Performing tests in 1:1 test facilities can have some disadvantages. Therefore some institutions are performing measurements on lighting control systems using miniaturised test-rooms (scale model testing). This has some advantages. The room parameter of miniaturised test-rooms (reflection factors of the room surfaces, relative dimensions, room-orientation, window sizes and orientations, etc.) can easily be changed compared to large 1:1 test rooms. The possibility to change the orientation of the room (correspondingly the window orientation) is a big advantage of such scale model testing, also the flexibility and mobility of small-scale model rooms, which allow testing in different climatic regions. Although the scale model testing is a useful tool, the disadvantages of such procedures have to be named. Normally the measuring of the illuminances can be a problem if one wants to transfer the results directly to a 1:1 room because of the fact that the room dimensions are scaled down, but the measuring device is not. The relative detection area of the photometer-heads compared to the room size is therefore different (in the scale model averaging over a larger area takes place).

At the institute for Electronics and Lighting Technology of the Technical University Berlin a scale model testing facility is used to assess additional information on control systems and also daylight systems in order to compare them to results of the 1:1 test-room results. The scale model room is a 1:4 scale model of the realistic 1:1 test rooms for daylight responsive lighting control systems. The room has the dimensions $B \times H \times T = 1\text{m} \times 1.2\text{m} \times 2\text{m}$, its reflection factors and the window size corresponds to the 1:1 rooms. The room is mobile and weather-resistant (outdoor use) and can be used in different situations. For practical reasons, the test room is located on the top of the building of the faculty in order to create a building situation without obstruction. A further feature of the facility is that the room can be rotated horizontally in different orientations via computer commands in order to simulate different azimuth angles. Testing cycles therefore in some cases can be performed in a shorter time period. The room is equipped with a bus system and a complete artificial lighting installation, including dimmable electronic ballasts, permitting the option to test different kinds of control systems, also bus-based solutions, e.g. EIB controller. Because of its geometry the room is equipped with three rows of luminaires, which is useful for testing of strategies for room depth dependent dimming (with an additional inner wall, one can change the room depth correspondingly). The room is equipped with 20 photometer-heads measuring the illuminance distribution in the room. Additionally the power consumption of the luminaires is measured. All the data is collected

over the measuring time with an automated data acquisition system. The data acquisition software also calculates the daylight contribution on the measured illuminances, i.e. the measured information corresponds to the 1:1 testing. Finally it can be said that scale model testing always have to be combined with tests in realistic 1:1 test-rooms, in order to have the possibility to determine the limitations of the scaled test-system.

CHAPTER 5

USER REACTIONS TO DAYLIGHT RESPONSIVE CONTROLLED LIGHTING



5.1 Introduction

The purpose of this chapter is to discuss why and how to introduce a lighting control system to the occupants of the building.

Experiences with complex control systems show that problems may occur when the users do not know what the purpose of the control system is and how it works. These problems can vary from complaints to completely overruling of the system through sabotage, which may lead to reduced energy savings.

Understanding and acceptance of the control system are important keywords for this chapter. They form the basis for achieving energy savings and improved lighting comfort. In short: the user has to know why the system has been installed, what it offers and how to use it.

5.2 User awareness

The user awareness is the understanding of the control system by the users of the space, the awareness that and why the system is there and how it works. In most cases the control system is noticed, either by the observation of the dimming of the lamps or because the user has

to interact with the system (e.g. turning on lights that have been switched off automatically). To enhance the acceptance of the system it should be introduced to the users (see also chapter 6). This can be done by building or facility managers who explain briefly the purpose of the system, (e.g. the energy saving) and what the users can expect in terms of automatic control. They also have to explain how to use the switches or the remote control. And when the building manager is not always present, it is necessary to specify to the users where they can find documentation or technical support. To ensure that the information can be retrieved later by the users or by new employees it should be written down on paper or in electronic form. To explain the working of a control system properly the working of the sensor must be made clear to the user. In case of a system with the sensor on the ceiling facing down the user can be told that the sensor “sees” the brightness of the (working) surface and that the lighting will be adjusted automatically if this brightness changes. This brightness changes not only when the daylight contribution changes, but also when for example an additional light source (desk lamp) is used or if the desk is covered with a large piece of white paper. In both cases the lamps will be dimmed, which may be the contrary of what the user wants.

In case of a sensor looking to the window the user should be told what will happen when the blinds are closed.

5.3 Acceptance

A daylight linked lighting control system will not function properly when it is not accepted. If there are too many complaints from the occupants, the system will be forgotten or tampered with and there is no chance to achieve energy savings. When the users do not notice that the light is controlled in an automatic way no problems with acceptance are likely to occur, but otherwise user awareness, as described above, will enhance the chance of acceptance.

As people like to control their environment there should be a possibility to overrule the system. Therefore the remote control or switches, that offer this, will probably increase the user acceptance of the system, but the acceptance is influenced by the complexity of this manual control. If the system is too complex the user might get annoyed in his attempts to master it.

A lighting control system is better accepted if it reacts in a predictable way, for example when the sun shines on the façade and the electric lighting level is dimmed.

Changes in illuminance are mostly accepted when the system is reacting fast when an action is needed (e.g. sudden dark clouds) and slowly when the user should not notice it (e.g. increasing daylight in the morning).

A number of common complaints and their possible sources are mentioned in table 1. It should be kept in mind that the complaints can have other causes than the control system, even causes that have nothing to do with the lighting (but the control system

is used as scapegoat). It is therefore necessary to study each situation separately.

First of all, one should test whether the lighting control system works according to the specifications. If the complaints cannot be dealt with, ask a consultant or the manufacturer.

Most people are not aware of the electric lighting in a building, but if the lighting is not adequate, it becomes an important issue to them. Therefore it is necessary to take complaints seriously and put the situation right as soon as possible.

Also to avoid complaints, it could be useful to ask the occupants, after the installation, how they perceive the visual environment with the control system, if the illuminance level is acceptable and if no unwanted fluctuations occur. This can be done with a simple questionnaire or an interview.

5.4 Things to remember

- Install the system as it is mentioned to install. Use it the way it is prescribed.
- Don't set the illuminance too low. When the illuminance is too low people will bring their own luminaires or cover the sensor.
- To increase the acceptance of lighting in rooms, one should avoid discomfort glare from windows.

Table 1 Common complaints and their possible sources

Complaints	Possible sources and remedies
<p>Light switches on, although there is enough light, or</p> <p>Light switches off, although there is not enough light</p>	<ul style="list-style-type: none"> • Inappropriate strategy for application (closed loop when open loop is more appropriate or vice versa) or wrongly positioned sensors. • Calibration inaccuracies. If possible, adjust the set point, if not: contact the manufacturer.
<p>Too little light on the desk</p>	<p>Several possibilities:</p> <ul style="list-style-type: none"> • The illuminance level is set too low. If possible, adjust the set point, if not: contact the manufacturer. • The installed luminous flux is too low. Replace lamps, clean luminaires or change the total installation. • Control system does not maintain the minimum illuminance level (see above). • The plane that the sensor looks at has changed, for example as a result of movement or change of furniture. • One sensor is used for several workplaces and illuminance of the plane that the sensor looks at, is changed by a user of the room, for example by lowering or opening blinds. • Change of the situation characteristics (new furniture, other orientation of tasks, use of large white surfaces in the neighbourhood of a closed loop system)
<p>Light switches on and off almost constantly, or</p> <p>dimms up and down almost constantly</p>	<ul style="list-style-type: none"> • The system reacts too fast on changes in the illumination of the room. Change the delay time or adjust the light output or contact the manufacturer. • The sensor 'looks' into the lamps it controls. • The sensor is covered or the system is disturbed by extra lighting or blinds or by reflections of sunlight.
<p>Areas too dark especially in the back of the room</p>	<ul style="list-style-type: none"> • The system controls a group of luminaires and the sensor is mounted in the window zone. Use a master/slave connection with an offset for the lamps in the back of the room.
<p>Noise</p>	<ul style="list-style-type: none"> • Relays or other mechanical parts or electromagnetical ballasts
<p>Different lamp colours</p>	<ul style="list-style-type: none"> • Lamps which are dimmed an extreme very low level show a colour shift towards pink. • Lamps have different colour temperatures.

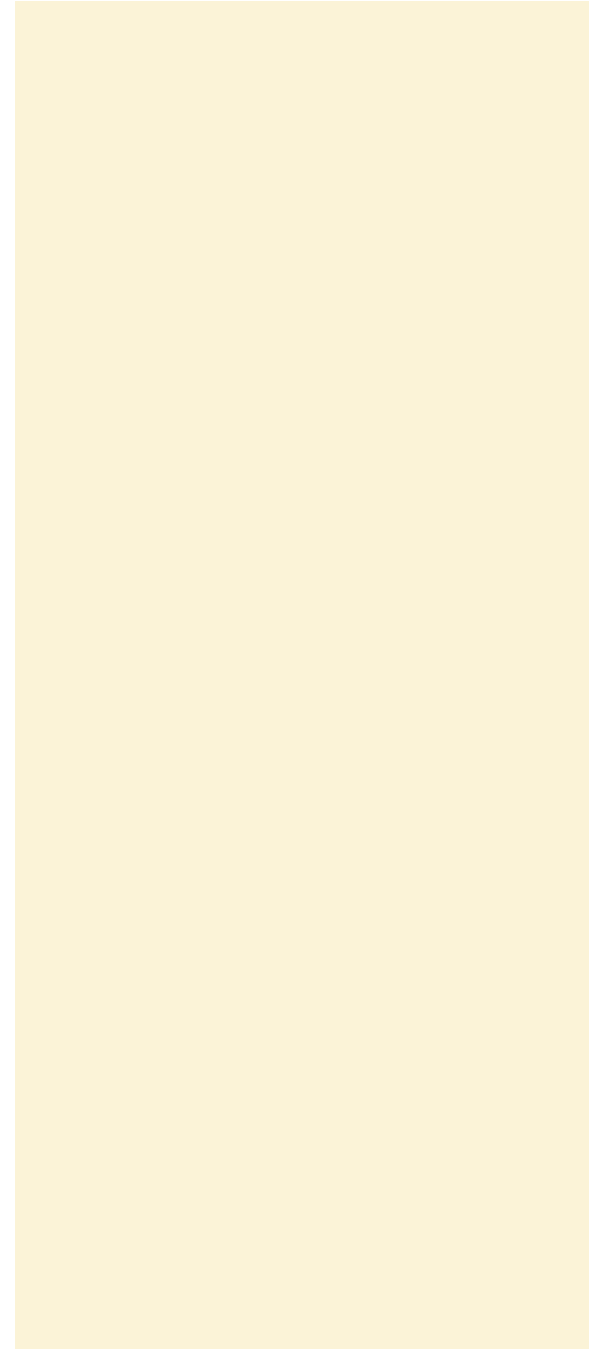

CHAPTER 6

INSTALLATION PROCEDURES

6.1 Introduction

In order to achieve user satisfaction and maximum energy saving it is important that the control system is installed correctly so that it will function optimally. Malfunctioning of the system will lead to complaints of the users or to reduced energy saving or even no saving at all. This chapter deals with the most important issues concerning the installation of the sensors for the different types of control systems. In order to keep the system running correctly after installation “system awareness” of maintenance personnel and occupants is necessary, this aspect is discussed in 6.6.

6.2 Installing sensors for closed loop systems

Most daylight linked closed loop control systems measure the combination of the daylight and the artificial lighting with a ceiling mounted or luminaire mounted light sensor. This sensor “looks” downward to the working plane. The output of the sensor is a measure of the light that reflects towards the ceiling and should be a measure of the light reflected by the working plane and the immediate surroundings. The

control system will not work properly if:

1. there is a light source (e.g. an uplighter) shining directly on the sensor or
2. there is reflected light (e.g. from a car parked outside or a shiny surface at a nearby building) or
3. the sensor “sees” a part of the window or
4. the sensor is blocked by objects (e.g. message panels, bookshelves, plants)

In these cases the reading of the sensor is not directly related to the luminance of the working plane and the control system will not work properly.

Therefore, the positioning of the sensor(s) should be done carefully.

All of the currently available sensors do not measure illuminance (lux values) on the workplane, but a kind of “average luminance” of it, which depends on the reflecting properties of the materials of the room and the furniture. Therefore there is a need for adaptation of the system in order to adjust the wanted “threshold” of dimming for each specific case with specific reflectances and initial (night time) illuminance levels.

6.3 Installing sensors for open loop systems

Daylight linked open loop control systems determine the contribution of the daylight to the lighting in a room by measuring the daylighting level outside the building and/or from the inside of the room and control the artificial lighting using predetermined algorithms.

The external sensor is placed on the roof or on the façade. In both cases care should be taken that the reading of the sensor is representative for the daylight contribution on the total building. There should be no



shading objects or highly reflective objects that are “seen” by the sensor, but are not influencing the daylight contribution on all parts of the building.

If the building is surrounded by large structures, which lead to a daylighting pattern on the façades that is not uniform, it should be considered to place more than one external sensor.

The internal sensor will have to “see” only the window, mostly it will be mounted near the ceiling “looking” to the window. Care should be taken that there are no obstructions or reflecting surfaces between the sensor and the window (except for the shading device), so that the reading will be representative for the luminance of the window including shading device.

6.4 Installing Luminaires with built-in sensors

The installation of luminaires with factory-installed sensors does not differ greatly from the installation of ordinary luminaires. Therefore this type of system is suitable for retrofit. No extra control cabling is necessary. After the luminaire is in place it is necessary to measure the illuminance on the work surface under each luminaire at night and during the daytime to see if the illuminance is at the desired level.

If the units have manufacturer pre-set installation settings these are based on assumptions on the average reflection factors in a typical office room. Once the system has been installed it may be necessary to make some adjustments. This can be checked by measuring light levels at different

locations to see what the actual performances are. If the combined levels are too high this is because the reflectivity of surfaces below the sensors (desktop) or the height of the ceiling may differ from the manufacturer-assumed conditions. Adjust the sensor setting until the desired lighting level is achieved.

With some systems the location of the sensor on the lamp itself can be readjusted to improve performance. For example, a sensor that can “see” the wall leads to different control behaviour than when it is located at the other end of the lamp and only “sees” the floor. Such fine-tuning processes may take some trial and error to optimise the system for a particular context.

Measuring and regulating based on luminance means also that, even in one specific room with a uniform lighting in terms of illuminance, there will be a non-uniform luminance distribution (due to different colours of i.e. furniture), leading to different adjustments for different luminaires.

Therefore there is a need for a certain regulating margin; as a result all manufacturers offer this feature on their systems, but different systems offer different possibilities. Possible systems are:

- changing of lenses with different optical transmittance (colour filters); mostly 3 (coloured) lenses giving the possibility to obtain 3 dimming thresholds. Manufacturers document it mostly as 3 illuminance levels for “normal” reflectances. These systems do not allow the possibility for continuous tuning, rather tune in steps of about 50%.

- tuning with a potentiometer (analog) gives the possibility to tune and adjust continuously thresholds of dimming levels even for “abnormal or non-uniform reflectances”
- tuning via a mechanical light passing aperture- or acceptance angle regulation: gives also the above-mentioned continuous tuning possibility.
- via infrared remote control eliminating the need to open the luminaire or manipulate the luminaire after closing it. Avoids the problem that the installer blocks the sensor when adjusting it.

The best way to tune an installation is:

- start with all sensors with equal setting in a representative room or room-partition (some manufacturers deliver sensors with a specified manufacturer setting)
- measure initial (night-time or covered windows, or on a not too bright day) illuminances on a few representative points (i.e. at the desk(s), conference table)
- tune the sensors; some manufacturers give simple rules for it (i.e. 10 % variation of dimming-threshold per turn of a regulating-device)
- based on this experience, pre-tune all sensors.

It is important to note that the so-called “constant-holders” require a more precise tuning than the systems which partly compensate (i.e. 50%) for incident daylight.

6.5 Installing room-based systems

The mounting position of the sensor is critical when there is one daylight sensor controlling multiple luminaires in a single zone or room. Most types of sensors are located in the ceiling and look down. Other more unusual wall or work surface sensor locations are not considered here.

The sensor:

- should view a part of the room which is relevant for the lighting to ensure that the lighting is controlled at the right place (e.g. placed over a work-surface and not over the floor)
- should have a surface in the field of view with a relatively large surface area, otherwise it will be difficult to predict if the control system will work.
- should not be able to “look outside”, because the extra signal from an uncontrolled area (outside, or from other lamps that are not controlled by the sensor) will lead to incorrect operation of the closed loop control system.
- should be located where it will not receive direct light from upward directed lamps when indirect (uplighting or pendant) lighting is used, as this could lead to oscillating behaviour of the system.

Unlike the self-contained units (where the sensor is installed in each luminaire) it will be necessary to provide additional cabling between the sensor and the luminaires. Power may be supplied to the controller or directly to the luminaires. If the wires for power and control are located close to each other there may occur electrical interference between them, so care should be taken to separate the wires properly.

Once the installation is complete, measurements of

illuminance levels in the room should be taken at night (or otherwise for rather low daylight contribution) and during daytime in required locations. If necessary the sensor should be adjusted to provide the desired levels.

Some systems allow the user to choose their personal illuminances within a certain range or even store preset values in the memory of the controller.

6.6 Installing building-based systems

In building based systems the daylight sensor controlling the electric lighting can be located outside of or inside some or all the rooms of which it controls the lighting.

Interior location:

If a sensor is placed in every room the installation of the system is similar to the installation of a room based system, except that the components are connected to a “bus” system.

If the sensor is placed in a representative room controlling the lighting in other, similar rooms, a consultant should be asked to determine the appropriate representative room. Care should be taken that the representative room has the same daylight contribution as the other rooms, and that no deviating shading patterns on the facade exist. If there are differences, corrections have to be calculated to assure the correct lighting in the different rooms.

Exterior location:

An exterior mounted sensor is normally located on

the building’s roof, although it is possible for sensors to be located on building facade(s) as well. These systems rely on algorithms that translate the exterior luminance pattern or distribution (incl. sun’s position) into a certain amount of lighting for each interior room. The effect of adjacent buildings (e.g. reflection) and obstructions (e.g. shading) should be taken into consideration during the placement of the sensor or during programming. The direction of view of the sensor is dependent on the type of system being installed. Because these systems are outside of the rooms they control, the effect of the interior shading devices is not taken into account unless an extra sensor is installed behind the blinds, or the control system also controls the blinds. In almost every situation professional assistance for the proper location and calibration of the sensor is required.

Another variation of building-based systems is when the lighting control system is connected to or integrated with a Building Management System. In this case it is possible for the BMS computer to monitor or overrule the lighting control or to couple it with non-lighting building systems. This can be useful when, for example, lights are turned off for holiday periods or the performance of the heating and lighting systems are adjusted to compliment each other. In terms of installation this means that all building systems may need extra cabling to connect them to the BMS. In other concepts the lighting control system and the BMS share the same bus line. Building management systems require trained personnel. These systems can take into account shading devices and they offer the possibility to control different building installations, for example,

diminishing the cooling when less artificial light is used.

Automatic shading control is also a form of building-based control when exterior shades or awnings are adjusted automatically by controllers. Sometimes this type of automatic control is also used for interior shading that is located in an inconvenient location such as in a skylight or high windows.

6.7 System awareness

An important, but often overlooked aspect of installation is the training of maintenance personnel and building occupants in the operation and purpose of the daylight responsive control systems. Although most manufacturers will provide technical support during and for a period following the installation of their system, it is easier and likely more economical if most problems can be addressed by those managing and occupying the building themselves.

Building and facility managers need to be aware of how to operate the system and to adjust it accordingly. They must be trained to answer questions that may come to them from occupants. They need to be aware of the normal performance of the system and how to spot typical problems associated with commissioning. For simple systems this information is found in the operation manuals. For more complex systems special training sessions from the manufacturer are necessary. Most manufacturers will provide some technical

support.

Building occupants should receive information about the purpose of the system. One approach may be to place such information in documents normally found in each office such as the company telephone or personnel book. The following is an example of text used to explain the Philips TRIOS Multisense luminaires:

The light fittings in your area are fully intelligent and will adjust themselves automatically according to the level of ambient light and switch on by movement detection if the area is occupied. Some fittings might look brighter than others. This is quite normal, since ambient light conditions might differ. Some fittings may have switched off completely since no one occupies the area or sufficient daylight is available.

Any further questions relating to the lighting in your area should be referred to the person in charge of the facility.

6.8 Selecting a consultant

In most cases the manufacturer of the daylight responsive control system will be able to provide or suggest a suitable lighting consultant to assist in the proper installation of their system. A special “system integrator”, a person who is trained for this job, is needed for lighting control systems that are integrated with building management systems.

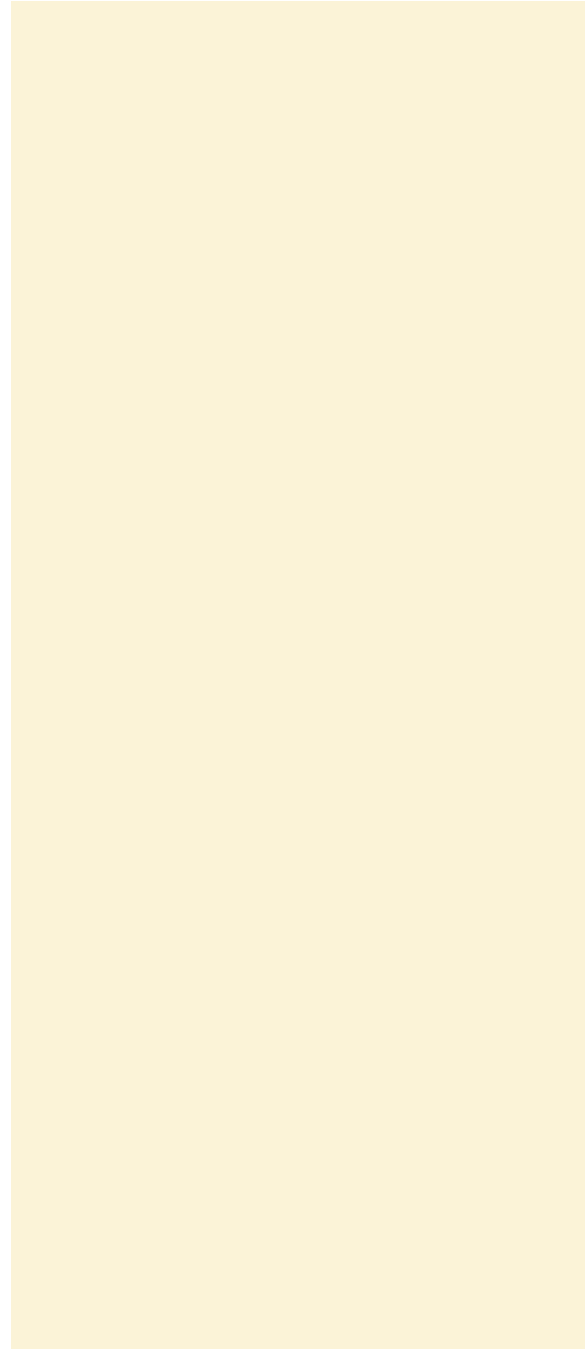



MAINTENANCE AND FLEXIBILITY

7.1 Introduction

This chapter discusses the factors that influence technical performance of the lighting system after installation.

A special emphasis will be on the aspects related to the functioning of daylight responsive control systems in time.

Modern lighting systems with electronic controls are capable of creating a pleasant atmosphere. At the same time such systems may be energy efficient. Unfortunately the electronics may partly fail - or more difficult to notice - malfunction.

So, once the lighting installation is in use and the controls are set up and tuned, maintenance is required to keep it functioning as expected.

Regular maintenance takes little effort and will ensure years long service of the installation

For those daylight systems that have moving parts, this is more obvious than for artificial lighting. For the artificial lighting it is generally not sufficient to simply replace broken lamps. Also luminaires have to be cleaned periodically and lamps have to be replaced after their economic life time because of their reduced light output.

Within the context of this Application Guide not all the issues related to maintenance can be

discussed in detail. Especially for artificial lighting standard cleaning and relamping and the relation with cost and energy use is discussed in most books on electric lighting [1].

Here mainly remarks will be made with respect to maintenance issues specific for daylight responsive controls.

Another aspect of the use of installations over time is the need to sometimes modify control parameters or even adapt the layout to accommodate changes in the demands from the user. This may be a change in the type of work or the visual task, rearrangement of furniture or a different partitioning of spaces.

Components will age and eventually fail. Proper regular maintenance will compensate for the effects of ageing and failure. Daylight responsive lighting control systems demand additional care in comparison with situations without control systems. It will be necessary to be aware of:

- Obstructed or dirty light sensors
- Malfunctioning of components
- Ageing and breaking down of components

The most common factors with respect to flexibility are changes in:

- the required lighting conditions within a space - mostly due to changes in visual task(s) or changes in occupancy
- the daylight availability; in most cases a result of modification of the external obstructions (for example new buildings and growing / changing trees)
- the interior; such as relocating room partitions, new paint in a different colour, new furniture, etc.

7.2 The first stage: evaluation of initial performance

It is apparent that the lighting control system has to perform as expected after installation. Therefore, it is useful to check and document the system performance directly after installation and repeat these checks periodically. Suggestions for this evaluation can be found in this guide in Chapter 8 'Design Evaluation' and in Appendix A 'Monitoring Protocol'.

During the installation and in the initial period of use often other people are in charge of the technical installation than during normal service. Due to these mutations in personnel, information and documentation may get lost.

A example of what could happen in a large project is the project of the 'Palace of Justice' in Den Bosch, the Netherlands (see case ..). After one year of actual use of the building the occupants identified the solar shading system to be the cause of a number of complaints, but already then it was difficult to find out which company installed this system. During the building phase a number of responsible managers of the constructing company did not see the need to pass on (as was apparent later) critical system information to the end user.

When good documentation and a description of the systems and their performance are available it is possible to compare real performance with the design expectations.

7.3 Changes in the required lighting conditions

Organisations nowadays change continuously which leads to adjustments in use of spaces and to combinations or new spaces. This may lead to the need to adjust the lighting controls. This is especially important for daylight responsive controls of electric lighting. Systems with ceiling mounted sensors react to the average luminance below the sensor. So as long as these luminances are not seriously affected there is no need for re-adjustment.

When partition walls are changed sometimes new arrangements have to be made in the more complex control systems. In the case of bus based systems these changes may require special action. Often the system has to be re-programmed by trained personnel to ensure proper functioning. The reprogramming is needed to define new groups of luminaires which are controlled according to the new spaces or users. Luminaire based systems might not need to be changed.

A special problem is a drastic change in average work surface reflectance under ceiling mounted sensors. As explained in previous chapters these sensors react on the average luminance of the work surface. This means that changes in average reflection will influence the average illuminance from the lighting control system. So the system needs to be re-calibrated in case of significant (>10%) change in the average reflectance. This involves measurement of illuminance and adjustment of system parameters (in luminaire based systems often adjustment of the hardware, in other systems adjustment of software

parameters in the control software).

Ceiling mounted sensors will fail to work correctly for extremely low reflectances. This may occur for instance in a space with a very dark floor. When too little daylight and or electric light is reflected no significant luminance can be seen by the sensor the system will compensate this with a maximum (full) output and no dimming occurs.

Changes in the required lighting conditions can also be required by changes in visual task(s).

In recent practice complaints about the electric lighting in a workspace revealed the following. The workspace is a large drawing room. Originally the lighting in this room was laid out to accommodate the drawing on large drawing boards, typically a visual task which demands high vertical illuminance values in order to see small details on inclined surfaces. Recently however the drawing boards have been replaced by computer based drawing systems equipped with computer screens. Of course this visual environment demands much lower vertical illuminances and luminaires that are sufficiently shielded to avoid direct and reflected glare. In that situation the lighting installation of the 'drawing room' has to be adapted for the new task by replacing the luminaires (optics).

Apart from such drastic changes, more subtle adaptations of the lighting may be necessary. In many cases the maintained lighting levels need adjustments. There is always a number of persons who prefer less or more light. Switching groups of luminaires or adding (task) lighting or

adapting the reference setting of the control system are possible structural solutions. The complexity of the last adjustment is dependent on the type of system and hence should be an issue in the initial selection of the system.

Daylight responsive controls are often part of a more extensive control system. However, already the simplest lighting control systems have the possibility to adjust the set point.

Most computer-based systems require the adjustment of a parameter in the control software. Other systems (some luminaire based systems) demand physical adjustment of the sensor often in combination with illuminance measurements. This may be very time consuming.

7.4 Ageing of components

The ageing of the components of a daylight responsive lighting control system can be subdivided in two parts: the lighting installation (lamp, luminaire) and the control system (sensor and controller).

The most obvious component in the lighting installation is the lamp. The lamp life (time after which 50% of the lamps will probably fail) reflects the number of hours that a lamp is expected to burn. The use of a control system might influence the lamp life negatively, as a result of switching lamps on and off more than without the use of the system. However – as a result of this switching – the burning hours per year for the lamps are less than for the case of lamps that are not controlled. Therefore the replacement time can effectively be equal or even longer than without daylight linked control.

An additional benefit of the use of a control system is that the effect of lamp ageing can be compensated by a control system. Because of the expected lamp depreciation artificial lighting installations have to be over dimensioned. Due to the control system the lamps are dimmed in the beginning, thus compensating for the extra power installed and gradually regulate to full output when the lamps depreciate over time. With this “constant lux” feature energy will be saved.

Besides by the ageing of the lighting installation components, the efficacy of the system can be influenced by the ageing and degradation of the sensor. Little is known about ageing of the light sensors, but some conclusions can be drawn up till now:

- It is well known that certain older types of Light Dependent Resistors [LDR] degrade over time. In some cases a difference of more than 50% in one year has been recorded. LDRs used in the individual lighting control systems today are regenerating automatically. This requires a sufficient amount of light. This means that if the sensor is used in a very dark environment (with little or no daylight and a low artificial lighting level), after some time problems may occur.
- Serious problems can be caused by the degradation of certain types of plastic used in the white diffusing covers of cells.
- Photo diodes are known to be very stable over time.

The life of the electronics used to drive the lamp and possible the electronics of the control system play a role. In general it is assumed that the electronics live longer than the lamps.

7.5 Malfunctioning of components

System failure can have multiple causes. Some failures are difficult to notice especially when the visual comfort is not affected. This is for instance the case when the daylight responsive dimming function of an electric lighting installation does not work: the lights will stay on and so there is sufficient light. No energy will be saved however.

What may happen is that an electronic circuit breaks down, or a light sensor is short circuited or disconnected. If the failure in the electronics causes a constant voltage of 10V output at the sensor the lights will dim and eventually switch off. This will soon be noticed. In case of short circuit the control system will respond with maximum light output, in case of disconnection the controller reacts according to the system type as if no sensor is present (generally also with maximum output). Then user complaints are less likely.

7.6 Maintenance program

To prevent the system from degradation or loss in functionality (from the viewpoint of visual comfort as well as in energy savings) periodical inspection and

maintenance are essential.

In general it is advised to refer to the operation/maintenance manual of the manufacturer to find suggestions for the maintenance of the system. When lamps are replaced or cleaned as part of a normal maintenance program the sensors should be cleaned along with the luminaire. Whenever extensive re-lamping takes place illuminance measurements should be conducted and sensors recalibrated in order to secure proper functioning of the control system.

Depending on the type of control system, the light sensors might need some extra care. Sensors located on the outside of the building should be regularly checked to be sure they are clear of debris and do not suffer from weather damage (corrosion, yellowing).

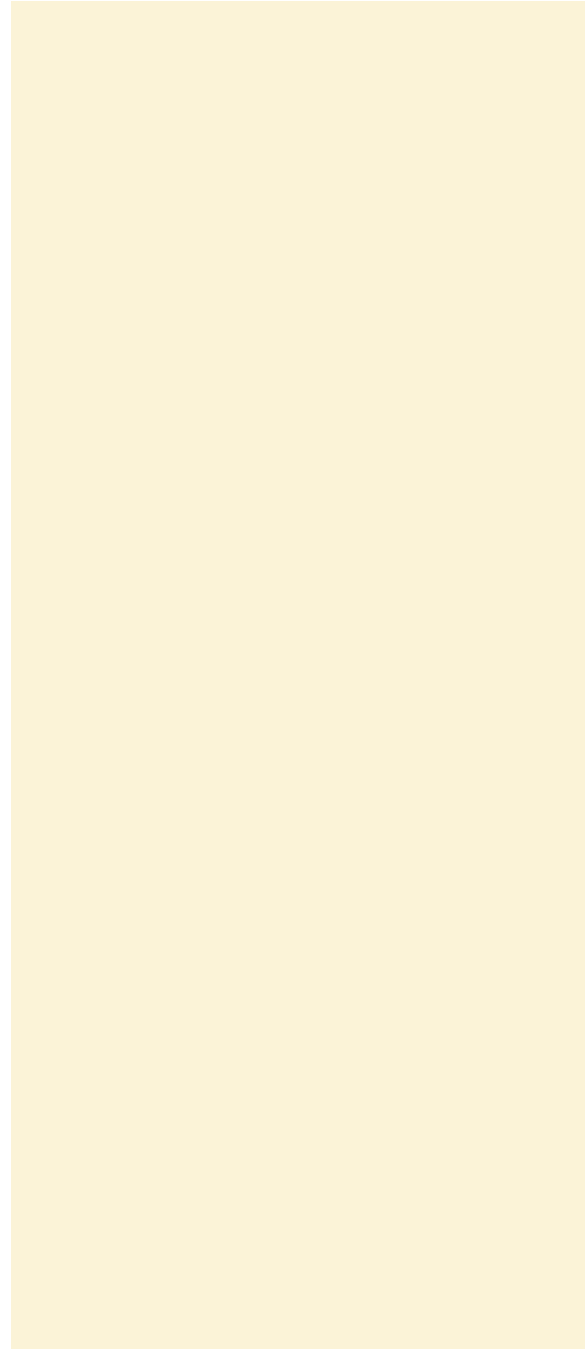



DESIGN EVALUATION

8.1 Introduction

To guarantee an optimised use of a daylight responsive lighting control system, it might be necessary to adjust the system some time after it is installed. In most cases the building owner/facility manager will be responsible to check whether the system is working as it is supposed to do. This chapter will show how to evaluate the system in use, technically and on user acceptance, and include information on possible methods to deal with complaints, preferences and technical problems.

8.2 Evaluation of the design

A daylight responsive lighting control system can be chosen to save energy, to improve comfort or to realise a certain image. In order to assure that the system fulfils the demands, evaluation could lead to improvement or adjustment of the system to meet these demands.

8.2.1. Technical evaluation

The technical evaluation contains the measurements of the maintained illuminance level and energy consumption.

8.2.2 Maintained illuminance level

An installed control system should at least maintain a certain (design) illuminance level and the lamp power when the illuminance falls below this. Whether the system fulfils this task can be checked with a calibrated light sensor, placed at the users' work plane. For a more extensive monitoring or long term monitoring a Monitoring Protocol is drawn up (see Appendix ...)

8.2.3 Energy savings

The reduction of energy consumption can be monitored with a kWh meter. To determine the energy consumption of the room without control system, the procedure is as follows:

- install a kWh meter just before installation of the control system and measure the energy consumption of the artificial lighting, or
- measure the energy consumption when the control system is installed, for 100% output of the artificial lighting, for example during the night
- use the installed power and the monitoring time to determine the energy consumption of the reference situation

To get a reliable assessment of the energy consumption with a control system, long term monitoring of the energy consumption is necessary, while the energy consumption varies significantly under different weather conditions. Therefore one should measure the energy consumption at least for two weeks, including different weather conditions and for different seasons. One whole year of monitoring is preferable. Also the time the lighting would be used

without the control system should be taken into account. User behaviour can vary between leaving lights on all the time and switching them off always when leaving the office or when enough daylight is present.

Total energy savings can be calculated according to:

Energy savings (%) =

$$100 \cdot (1 - Q_{\text{control}} / Q_{\text{reference}}) =$$

$$100 \cdot (1 - Q_{\text{control}} / (P \cdot T))$$

where:

Q_{control} total measured energy consumption of situation with control system

$Q_{\text{reference}}$ total measured energy consumption of situation without control system

P installed power

T total time over which the energy consumption is measured

8.3 User acceptance evaluation

In order to realise energy savings it is necessary that the user accepts the daylight responsive lighting control system. Acceptance is an important issue, especially when the system is installed to enlarge the comfort of the users. Both acceptance and comfort can be reviewed after installation of the control system.

An important aspect that can determine the acceptance of a system, is that one has to ensure

that the user understands how to work with and what to expect from the installed daylight responsive lighting control system. Therefore it is necessary to introduce the system and show the attributes that the system offer. More information can be found in the chapter on 'User Reaction to Daylight Responsive Controlled Lighting'.

There is no need for a specific questionnaire to be used to indicate problems coming with the daylight responsive lighting control system. Users of the building can be asked to write down whether they are disturbed by the lighting and / or blinds, or inform the building owner when there are specific problems. Besides this, it can be useful to go through the building, talk to the users and evaluate by observation, focussing on signs of sabotage.

When the user is disturbed, for example when there is too little light for him at his work place, or the blinds should be opened while the system keeps them closed, the user will mostly complain or try to sabotage the system.

This means that the control system cannot perform as it is supposed to do, or even not perform at all anymore. Intended energy savings will not be reached in this case. Therefore it is necessary to take user acceptance into consideration (see chapter 5).

CHAPTER 9



OUTLOOK

The studies conducted within Subtask B of IEA Task 21 showed that the vast majority of daylight responsive control systems only control the artificial lighting. The control of the entering daylight is will be left to the user or to another building system (mostly only sunscreening). The existing systems can be used with traditional windows with traditional sun or glare protection. For the combination with innovative daylighting systems no guidelines could be given, except for the general advices for installing sensors.

Existing daylight responsive artificial lighting control systems realise in practice an energy saving of 40 to 50% of the energy by dimming and switching off (sometimes even more energy can be saved by replacing old installations by new, high frequency lamps and ballasts in efficient optical systems). There is no tendency to improve these systems with respect to a higher precision in the maintenance of the illuminance level at the desk, since it might increase these energy savings only slightly. Only when energy costs increase it will be useful to focus on the last small percentages of extra energy savings that can be reached.

In some cases (e.g. single cell offices) presence detection combined with the lighting control can save around 50% energy because on average the office workplace will be occupied only 50% of the time. This type of lighting control has not been studied in this task, but many daylight

responsive control systems have presence detection as an optional feature, which can be more effective than the daylight responsive dimming.

It seems to be useful to focus on user acceptance and user interface. The existing control systems maintain a minimum task illuminance (daylight responsive artificial lighting control system).

Nonetheless, the variety in individual preferences is shown in various research (for task illuminances e.g. Tregenza et al. 1974, Halonen and Lehtovaara 1995, Begemann et al. 1997, Tenner et al. 1997, for discomfort glare from windows e.g. Hopkinson 1970, Osterhaus 1996, Velds 2000). The maximum and minimum set values might not be accepted by all users. Therefore, they should have the opportunity to overrule or influence the blind control. The actual control that the user should have over the lighting should be given consideration as well. Control over the workplace lighting can lead to a decrease of performance and influence the user's mood (Veitch and Gifford 1992). Stress and frustration can be caused by having too many choices and the requirement to make frequent adjustments in the workplace (Heerwagen et al. 1991). Additional research is required to obtain information on the necessary influence an user should have on a control system, to realise acceptable lighting conditions for each user.

Within this research project, the performance of daylight responsive artificial lighting control systems in situations with daylighting systems has not been studied. Whereas daylighting systems can influence the illuminance and luminance distribution in the room significantly, additional research with respect to this aspect is necessary.

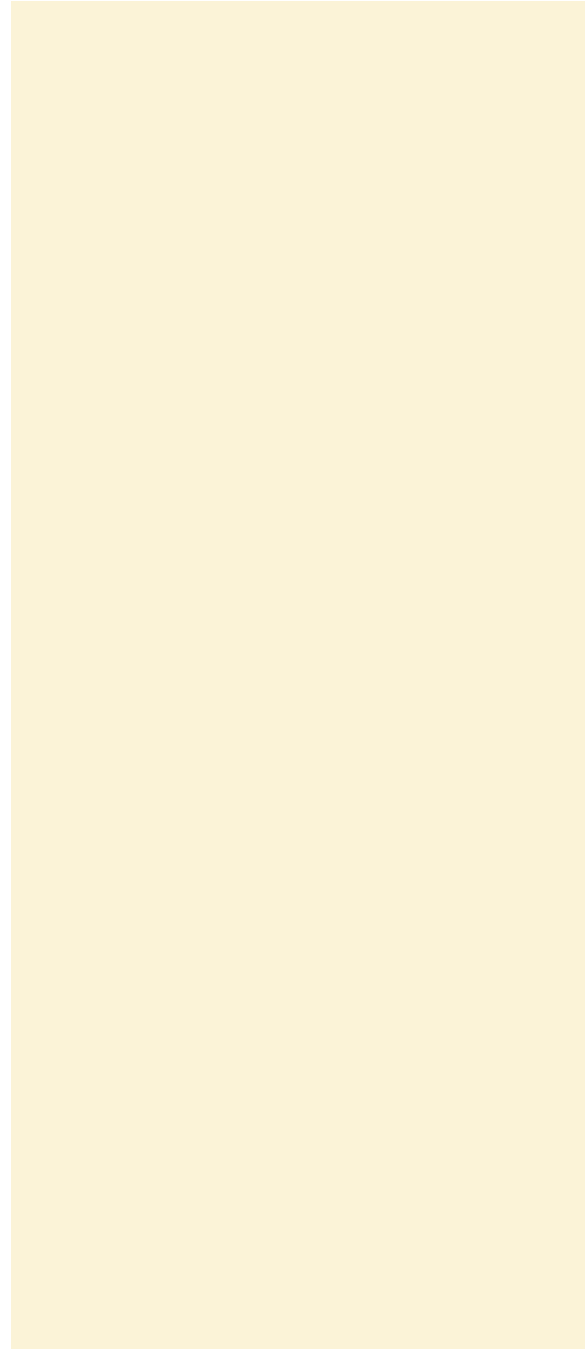

FURTHER READING

FURTHER READING

- N.C. Ruck, O. Aschehoug, J. Christoffersen, R. Jakobiak, K. Johnsen, E.S. Lee, S.E. Selkowitz, (Ed) 2001. Daylight in Buildings: A Source Book on Daylighting Systems and Components, Report of IEA SHC Task 21/ECBS Annex 29. Lawrence Berkeley National Laboratory, CA.,USA (In Press).
- IES Lighting Handbook, Illuminating Engineering Society of North America
- S.H.A. Begemann, M.P.J. Aarts, A.D. Tenner, Daylight, artificial light and people, Philips Lighting B.V., 1994, 8p.
- J.A. Love, Manual switching patterns in private offices, Lighting Research and Technology, Vol. 30-1, 1998, pp.45-50.
- C. Laurentin, V. Berrutto, M. Fontoynt, Manual control of artificial lighting in a daylight space, EPIC' 98, 1998, 6p.
- J.P. Bohrer, Evaluation of manual selective switching as an office lighting control strategy, Master's thesis, 1992.
- E. Vine, E. Lee, R. Clear, D. DiBartolomeo, S. Selkowitz, Office worker response to an automated venetian blind and electric lighting system: a pilot study, Energy And Buildings, Volume 28, n°2, 1998, pp. 205-218.
- S. Escuyer, V. Berrutto, M. Fontoynt, Testing in real offices of daylight responsive lighting control systems: a review of recent articles, EPIC' 98, 1998, 6p.

Chapter 4

- /1/ Baker N, Fanchiotti A, Steemers K (editors), various authors, Daylighting in architecture, A European Reference Book, Published for the commission of the European communities (director-general XII for science, research and development) by James & James Ltd., London 1993
- /2/ Hunt D R G, Improved daylight data for predicting energy savings from photoelectric controls, Lighting Research and Technology, Vol. 11 No. 1 1979
- /3/ Hunt D R G, Availability of Daylight, Building Research Establishment, Garston, 1979

Chapter 4.3

- /1/ DIN 5034 Part 2, Tageslicht in Innenräumen, German Standard, February 1985
- /2/ Aydinli S., Seidl M., Van Bergem-Jansen P.M., Keller B., Tageslichtanforderungen, Grundlagen, Berechnung, Messung, energetische Aspekte II-1.1, Innenbeleuchtung/Planung und Berechnung, Handbuch für Beleuchtung, 5. Auflage, Landsberg 1992

- /3/ Aydinli S., Seidl M., Determination of the economic benefits of daylight in interiors concerned with the fulfilment of visual tasks, Proceedings I, International Daylighting Conference, California U.S.A. November 4-7, 1986
- /4/ Aydinli S., Krochmann J., Seidl M. Possibilities for energy saving for electrical light by daylighting of interiors in consideration of the visual task. Proceedings, European Conference on Architecture. Commission of the European Communities. Munich, Germany, 6-10 April 1987
- /5/ Aydinli S, Hornoi O., Krochmann E., Tageslichtabhängige Steuerung von Beleuchtungsanlagen – Gewinn für alle ?, Tagungsberichte zur 10. Gemeinschaftstagung der Lichttechnischen Gesellschaften Deutschlands, der Niederlande, Österreichs und der Schweiz, Licht 92 in Saarbrücken, 1992
- /6/ Ehling K., Knoop T., Aydinli S., Kaase H., Energy efficient and ergonomic lighting by innovative daylight systems and building management systems. Proceedings, LUX EUROPA 1997, Amsterdam 11-14 May 1997.
- /7/ Knoop T., Ehling K., Aydinli S., Kaase H., Investigation of daylight redirecting systems and daylight responsive lighting control systems. Proceedings Right Light, 4th European Conference on Energy-Efficient Lighting, Copenhagen, Denmark, 19-21 November, 1997
- /8/ Belendorf H., Aydinli S., Kaase H., A practical method for the assessment of daylight responsive lighting control systems regarding energy saving and lighting quality, EuroSun 2000, Kopenhagen, 2000
- /9/ Belendorf H., Aydinli S., Kaase H., Ein praxisorientiertes analytisches Verfahren zur energetischen und lichttechnischen Bewertung tageslichtabhängiger Kontrollsysteme, Licht 2000, Goslar, 2000
- /10/ Belendorf H., Aydinli S., Kaase H., A comprehensive method for the prediction of energy-savings using daylight-systems and daylight-responsive lighting control systems, Lux Europa 2001, Reykjavik, 2001

Illustrations

The photographic illustrations in this application guide are reprinted from International Lighting Review, published by Philips Lighting Luminaire Group, with permission of the publisher.